

SUN TOP TRADE · COMMERCIAL TRACK LIGHTING

ERDU.

Flexible track lighting.

Field-cutable, in-situ-foldable track lighting for retail, gallery, hospitality and high-end residential. R300mm minimum bend radius.

Supplied in 5 / 10 / 20 metre rolls. Compatible track-mounted spots and linear systems. AU-compatible drivers, SAA certification on request.



01

02

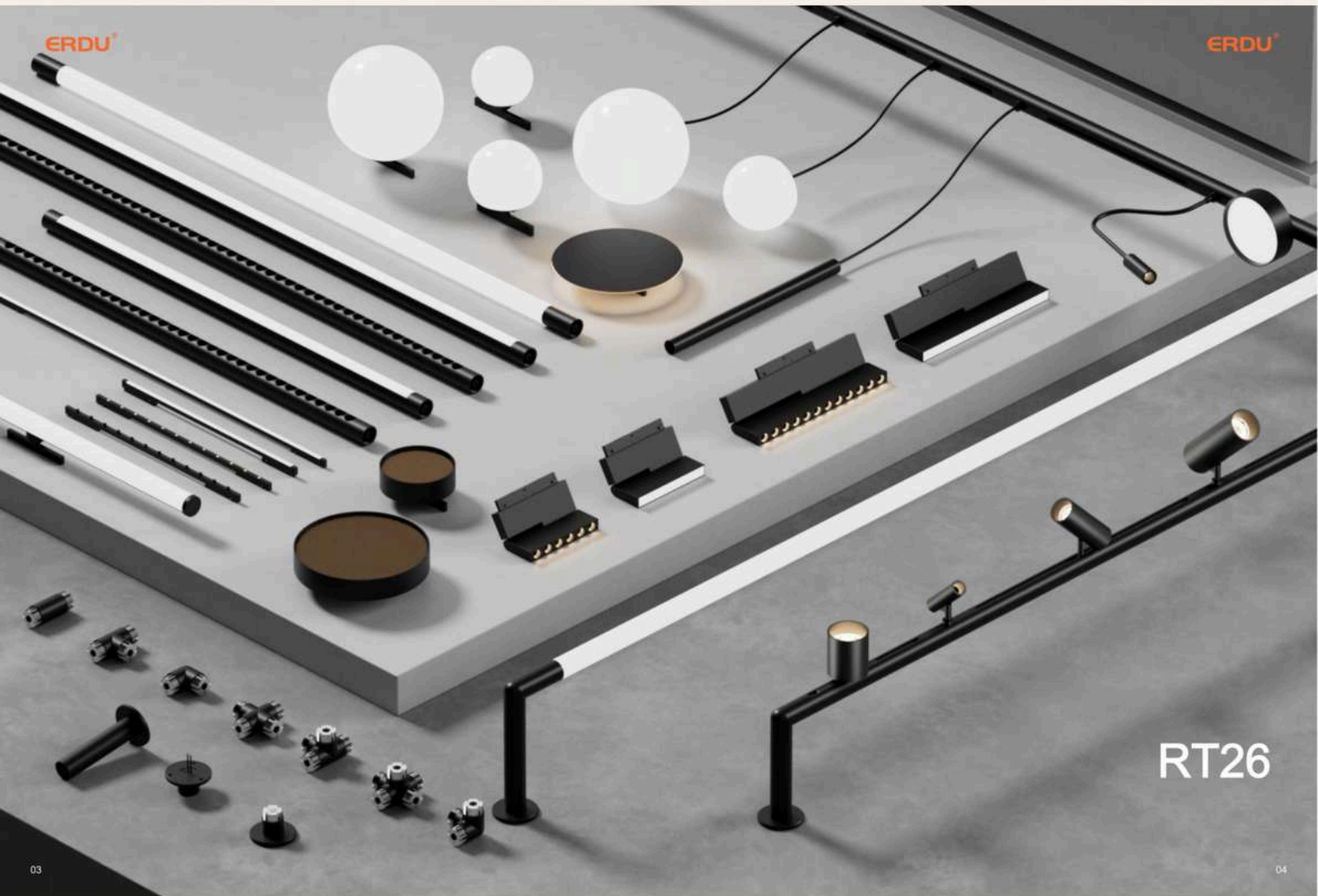



TB-24V 灯具及轨道

TB-24V Luminaires & track

TB 系统只需一套系统即可满足各种照明需求它可以与 TB-DFS、TB-GLR 和 TB-PC 等线性灯具组合使用，营造出独特的照明效果。为了获得最佳的办公室照明效果，TB-track 可与 Nano (5毫米) 系统灯具组件组合使用从而为照明设计带来更大的灵活性

TB system fulfils a wide range of lighting requirements with just one system.it can be combine with TB-DFS,TB-GLR and TB-PC these linear luminaires achieve for a special effect. For optimum office lighting,TB-track can be combine with Nano (5mm) system luminaires inserts for even more flexibility in lighting design.



RT26

Material - Extruded aluminum profile
Surface treatment - Available in white, black
Powder coating of other colors, can be customized upon request.You Can cut by yourself
Size - Diameter: 26.6",Length: 1000/1500/2000 Other size can be customized upon request.



RT26-O-1M/1.5M/2M

Material - Extruded aluminum profile with built-in pure copper wire guide
Surface treatment - Available in white, black
Powder coating of other colors, customizable upon request.
Size - Diameter: 26.6",Length: 1000/1500/2000 Other size can be customized upon request.



RT26-18T/36T/54T

Material - aluminum extruded
Finished - with selection of white, black & other colors powder coating finishes on requested.
Wattage - 8/18/24W
Beam Angle - 36°
CCT: 3000K, 4000K, 5000K
Size - L374*D26.6,700*D26.6,1020*D26.6



RT26-370/700F/1000F

Material - aluminum extruded
Finished - with selection of white, black & other colors powder coating finishes on requested.
Wattage - 8/18/24W
Beam Angle - 120°
CCT: 3000K, 4000K, 5000K
Size - L374*D26.6,700*D26.6,1020*D26.6



RT26-TUBE370/700/1000

Material - aluminum extruded
Finished - with selection of white, black & other colors powder coating finishes on requested.
Wattage - 8/12/15W
Beam Angle - 360°
CCT: 3000K, 4000K, 5000K
Size - L374*D26.6,700*D26.6,1020*D26.6



普通通过简单的旋转、插入实现电气和机械连接，这使得复杂照明系统的安装极其简单、快速和直接。

The pipes are connected electrically and mechanically by simply twisting and inserting. This makes the installation of complex lighting systems extremely simple, fast and straightforward.



TUBO 系统灯具实现 360° 配光和乳白色灯罩，可实现均匀照明，并随得提升地区亮度。这使得该系统灯具非常适合需要营造舒适环境照明的场所

TUBO system luminaires offer 360° light distribution and opalescent shades for even illumination and slightly brighter areas. This makes them ideal for locations that require comfortable ambient lighting

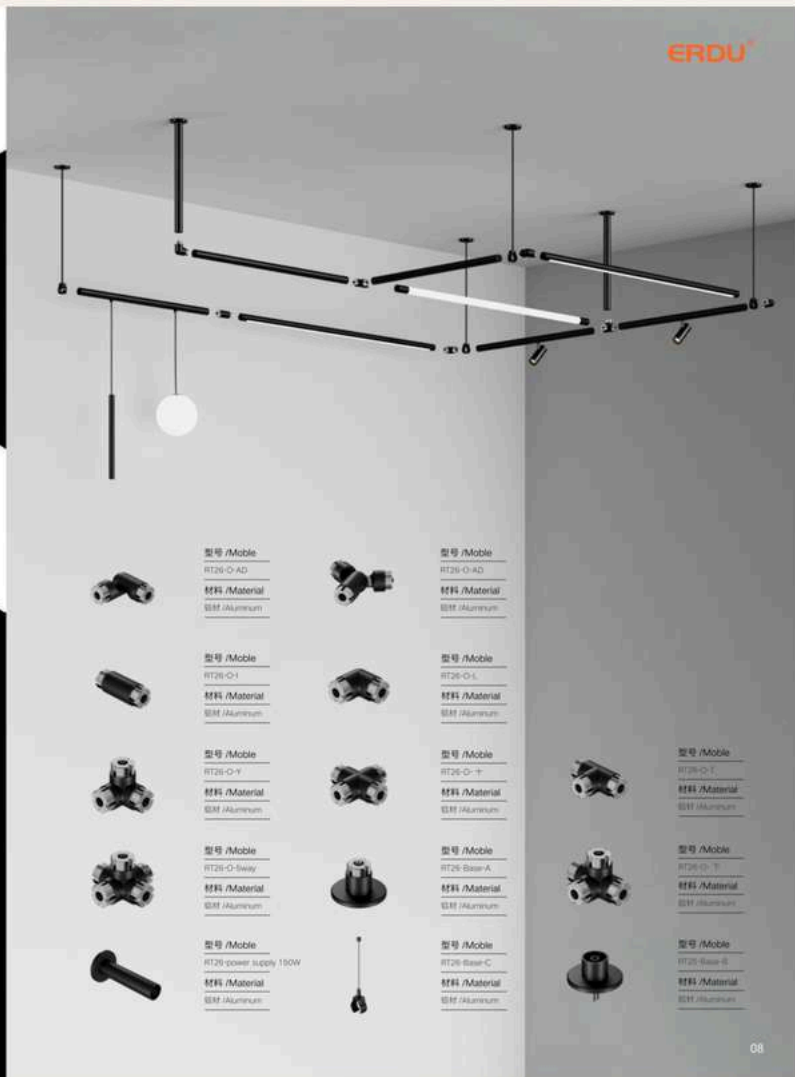
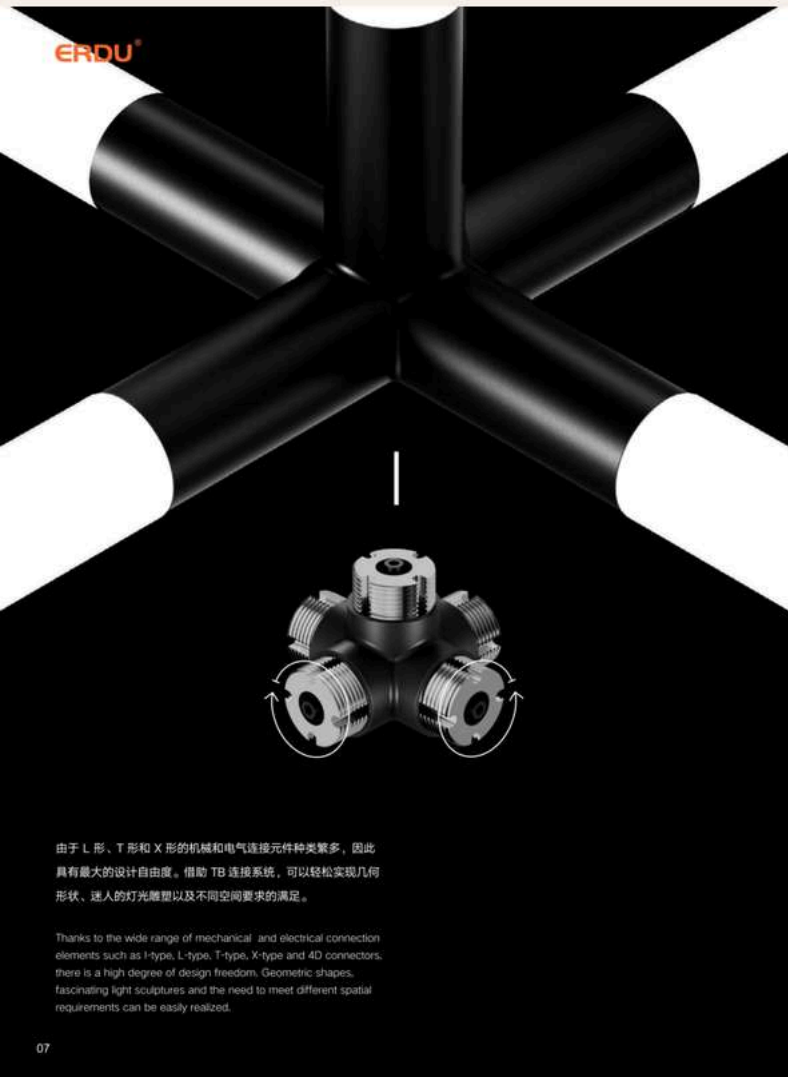

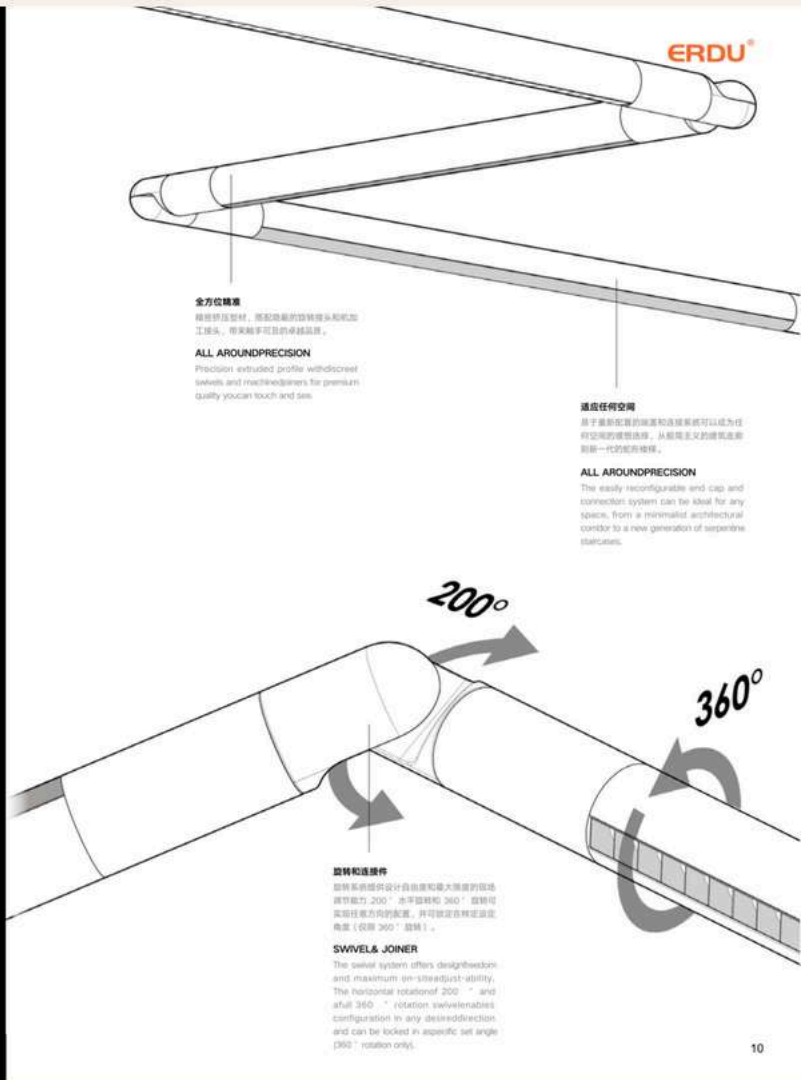





无限变换, 以下是我们探索出的形状和图案,
还有更多丰富的形状等着你去创造。

Infinite transformations, the following are the
shapes and patterns we explored, and more rich
shapes are waiting for you to create.



激活光的万千形态, 重塑你的空间想象
从极简线条到星河璀璨, 更多惊艳光影

Activate the myriad forms of light and reshape
your spatial imagination.
From minimalist lines to brilliant stars, more
stunning light and shadow.



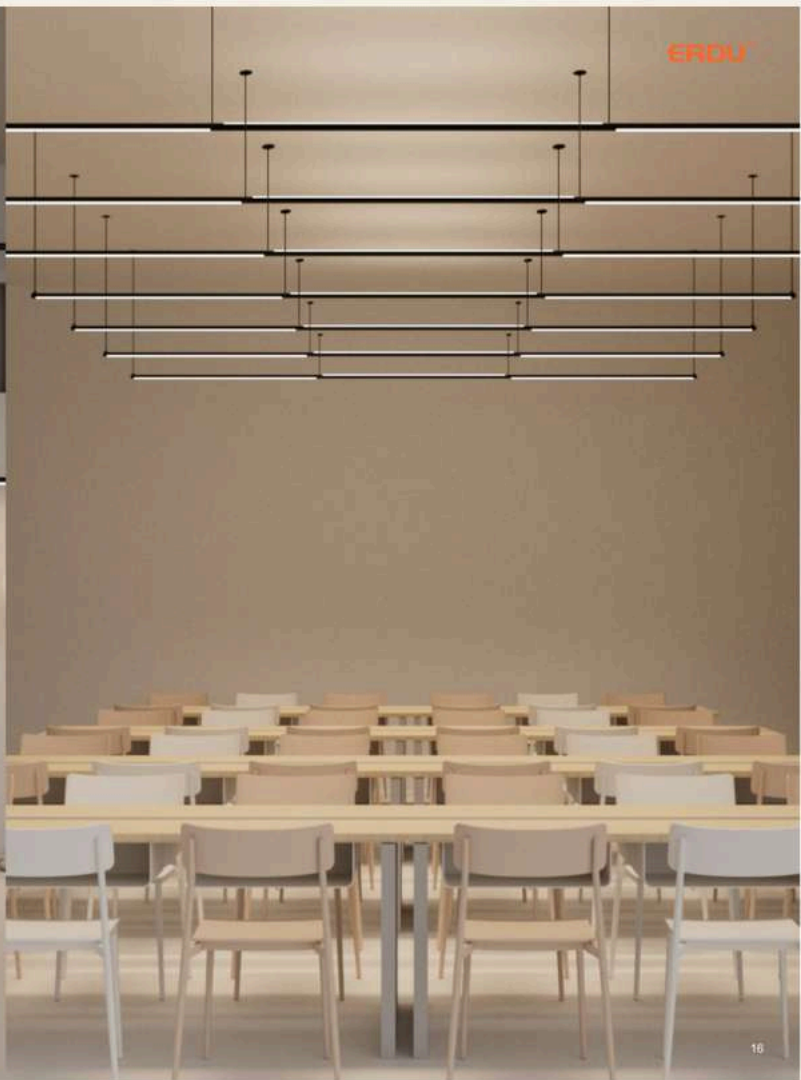

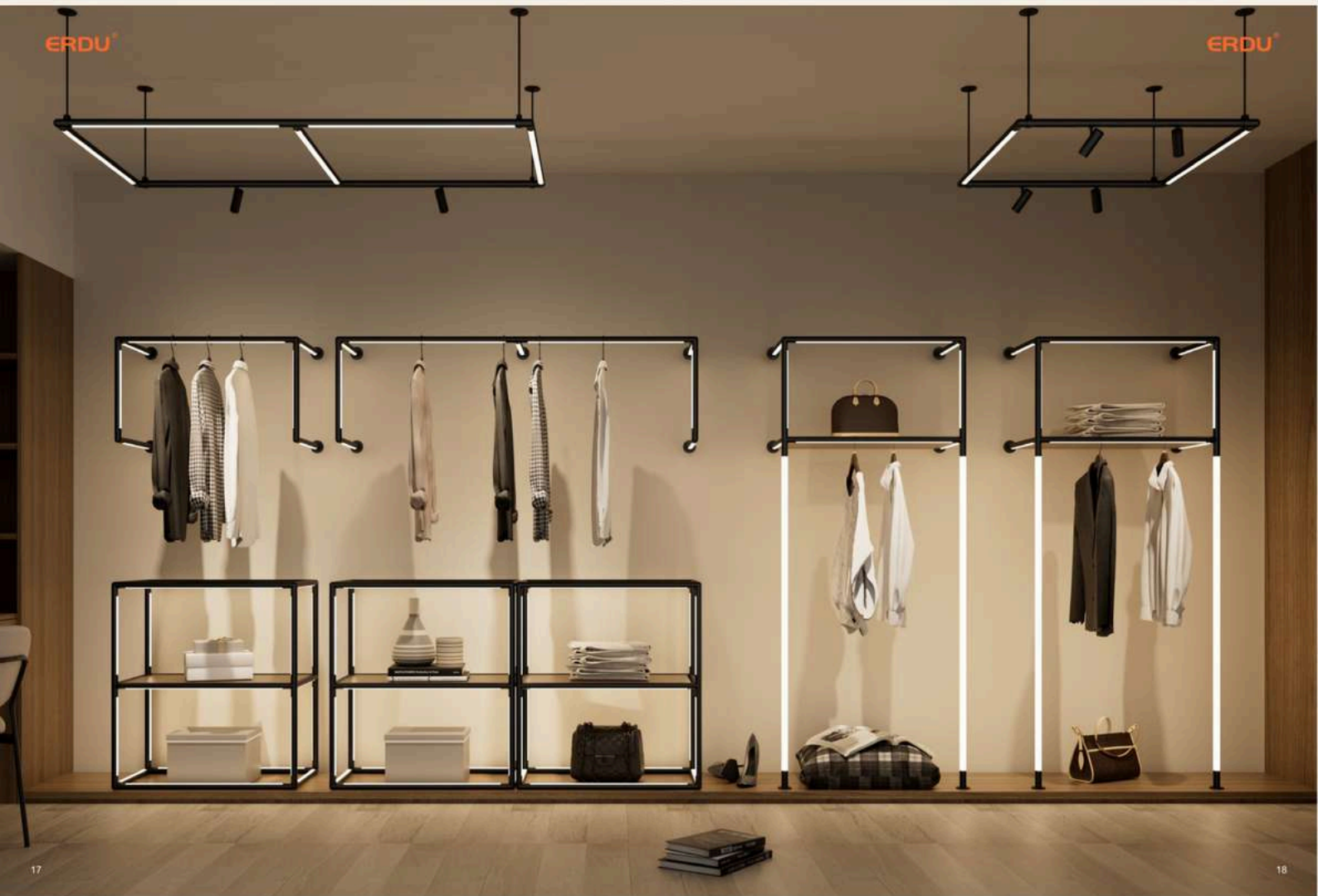

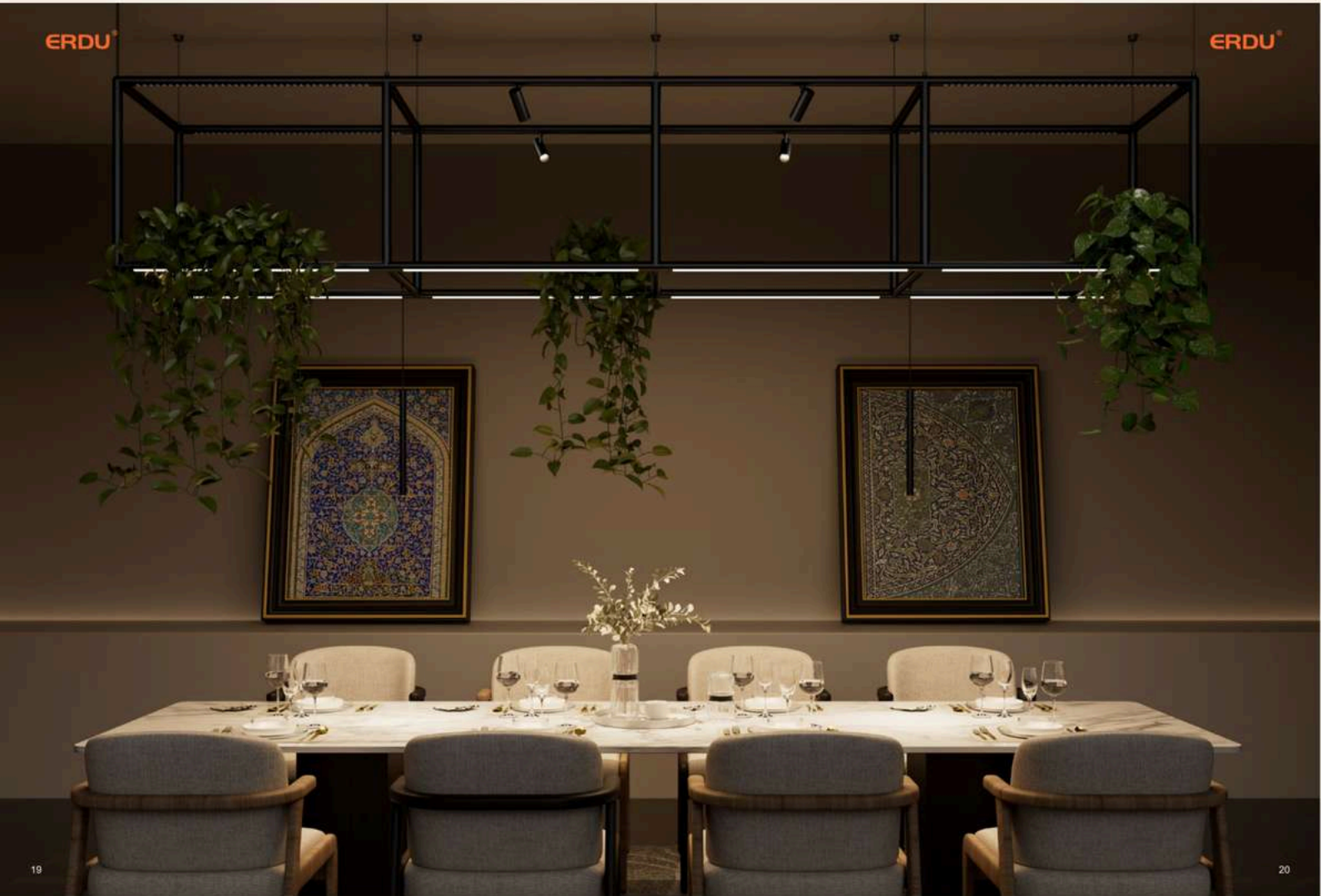





线性格栅灯
LINEAR GRILLE LIGHTS

线性泛光灯
LINEAR FLOODLIGHT



折叠格栅灯
FOLDING GRILLE LIGHTS

折叠泛光灯
FOLDING FLOODLIGHT

UNS-12T 尺寸 / SIZE (MM)

功率 / Power 6W
光束角 / Beam angle 60°
色温 / CCT 3000K/4000K/5000K

UNS-300F 尺寸 / SIZE (MM)

功率 / Power 9W
光束角 / Beam angle 120°
色温 / CCT 3000K/4000K/5000K

UNS-600F 尺寸 / SIZE (MM)

功率 / Power 18W
光束角 / Beam angle 120°
色温 / CCT 3000K/4000K/5000K

UNS-ZD-6T 尺寸 / SIZE (MM)

功率 / Power 6W
光束角 / Beam angle 24°
色温 / CCT 3000K/4000K/5000K

UNS-ZD-12T 尺寸 / SIZE (MM)

功率 / Power 12W
光束角 / Beam angle 24°
色温 / CCT 3000K/4000K/5000K

UNS-ZD-6F 尺寸 / SIZE (MM)

功率 / Power 6W
光束角 / Beam angle 120°
色温 / CCT 3000K/4000K/5000K

UNS-ZD-12F 尺寸 / SIZE (MM)

功率 / Power 12W
光束角 / Beam angle 120°
色温 / CCT 3000K/4000K/5000K

灯体颜色 / Light Color	
颜色 / Color	
通用规格 / General specifications	
灯体材料 / Material	铝材 / Aluminum
扩散器材料 / Diffuser	透镜 / Lens
防护等级 / IP	IP20
工作温度 / Warranty	-25° C - 50° C
质保 / Warranty	5 YEARS
电压 / Voltage	24V

灯体颜色 / Light Color	
颜色 / Color	
通用规格 / General specifications	
灯体材料 / Material	铝材 / Aluminum
扩散器材料 / Diffuser	透镜 / Lens
防护等级 / IP	IP20
工作温度 / Warranty	-25° C - 50° C
质保 / Warranty	5 YEARS
电压 / Voltage	24V



轨道射灯
TRACK LIGHTS



圆球灯
TRACK BALL LAMP



双层玻璃球
DOUBLE LAYERED GLASS BALL



轨道式-月球
TRACK TYPE-MOON
UN5-GDD150



轨道式-地球
TRACK TYPE-EARTH
UN5-GDY150

UN5-L20 R寸 / SIZE(MM)

功率 / Power 2W
光束角 / Beam angle 24°
色温 / CCT 3000K/4000K/5000K
扩散源材料 / Diffuser Lens

UN5-L33 R寸 / SIZE(MM)

功率 / Power 5W
光束角 / Beam angle 24°
色温 / CCT 3000K/4000K/5000K
扩散源材料 / Diffuser Lens

UN5-L43 R寸 / SIZE(MM)

功率 / Power 12W
光束角 / Beam angle 24°
色温 / CCT 3000K/4000K/5000K
扩散源材料 / Diffuser Lens

UN5-P95 R寸 / SIZE(MM)

功率 / Power 5W
光束角 / Beam angle 180°
色温 / CCT 3000K/4000K/5000K
扩散源材料 / Diffuser Glass

UN5-B80 R寸 / SIZE(MM)

功率 / Power 5W
光束角 / Beam angle 180°
色温 / CCT 3000K/4000K/5000K
扩散源材料 / Diffuser Glass

UN5-GDD150/UN5-GDY150 R寸 / SIZE(MM)

功率 / Power 5W
光束角 / Beam angle 360°
色温 / CCT 3000K/4000K/5000K
扩散源材料 / Diffuser Plastic

灯体颜色 / Light Color	
颜色 / Color	黑色 / Black
通用规格 / General specifications	
灯体材料 / Material	铝材 / Aluminum
防护等级 / IP	IP20
工作温度 / Warranty	-25° C-50° C
质保 / Warranty	5 YEARS
电压 / Voltage	24V

灯体颜色 / Light Color	
颜色 / Color	黑色 / Black
通用规格 / General specifications	
灯体材料 / Material	铝材 / Aluminum
防护等级 / IP	IP20
工作温度 / Warranty	-25° C-50° C
质保 / Warranty	5 YEARS
电压 / Voltage	24V



明装圆形射灯
SURFACE MOUNTED SPOTLIGHTS



日蚀壁灯
SOLAR ECLIPSE WALL LAMP



明装泛光灯
SURFACE MOUNTED FLOODLIGHT

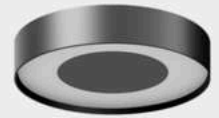

明装圆形射灯
SURFACE MOUNTED SPOTLIGHTS 9 IN 1

UNS-TD50 R11 / SIZE(MM)
功率 / Power 5W
光束角 / Beam angle 24°
色温 / CCT 3000K/4000K/6000K
扩散罩材料 / Diffuser Lens

UNS-YSBD R11 / SIZE(MM)
功率 / Power 5W
光束角 / Beam angle 150°
色温 / CCT 3000K/4000K/6000K
扩散罩材料 / Diffuser PC

UNS-WB90 R11 / SIZE(MM)
功率 / Power 5W
光束角 / Beam angle 120°
色温 / CCT 3000K/4000K/6000K
扩散罩材料 / Diffuser Lens

UNS-WB168 R11 / SIZE(MM)
功率 / Power 15W
光束角 / Beam angle 120°
色温 / CCT 3000K/4000K/6000K
扩散罩材料 / Diffuser Lens

UNS-G90 R11 / SIZE(MM)
功率 / Power 5W
光束角 / Beam angle 24°
色温 / CCT 3000K/4000K/6000K
扩散罩材料 / Diffuser Lens

灯体颜色 / Light Color	
颜色 / Color	Black
通用规格 / General specifications	
灯体材料 / Material	铝材 / Aluminum
扩散罩材料 / Diffuser	Lens
防护等级 / IP	IP20
工作温度 / Warranty	-25° C-50° C
质保 / Warranty	5 YEARS
电压 / Voltage	24V

灯体颜色 / Light Color	
颜色 / Color	Black
通用规格 / General specifications	
灯体材料 / Material	铝材 / Aluminum
防护等级 / IP	IP20
工作温度 / Warranty	-25° C-50° C
质保 / Warranty	5 YEARS
电压 / Voltage	24V



吊式棒吊灯
HOISTING-STRAIGHT CYLINDER



吊式棒圆球灯
SUSPENDED SPHERICAL LAMP



地球
SURFACE MOUNTED SPOTLIGHTS
UNS-D150



月球
SURFACE MOUNTED SPOTLIGHTS
UNS-Y150



轨道式阅读灯
TRACK TYPE READING LIGHT

UNS-30D300
R寸 / SIZE(MM)



300
30

功率 / Power
6W

光束角 / Beam angle
24°

色温 / CCT
3000K/4000K/6000K

扩散器材料 / Diffuser
Lens

UNS-DP95
R寸 / SIZE(MM)



95

功率 / Power
6W

光束角 / Beam angle
180°

色温 / CCT
3000K/4000K/6000K

扩散器材料 / Diffuser
PC

灯体颜色 / Light Color

黑色 / Black

通用规格 / General specifications

灯体材料 / Material	铝 / Aluminum
防护等级 / IP	IP20
工作温度 / Warranty	-25 ° C - 50 ° C
质保 / Warranty	5 YEARS
电压 / Voltage	24V

UNS-D150/Y150
R寸 / SIZE(MM)



150

功率 / Power
6W

光束角 / Beam angle
35°

色温 / CCT
3000K/4000K/6000K

扩散器材料 / Diffuser
Plastic

UNS-YDL20
R寸 / SIZE(MM)



20

功率 / Power
3W

光束角 / Beam angle
34°

色温 / CCT
3000K/4000K/6000K

扩散器材料 / Diffuser
Lens

灯体颜色 / Light Color

黑色 / Black

通用规格 / General specifications

灯体材料 / Material	铝 / Aluminum
防护等级 / IP	IP20
工作温度 / Warranty	-25 ° C - 50 ° C
质保 / Warranty	5 YEARS
电压 / Voltage	24V



软性线性灯
SOFT LINEAR LAMP

UNS-GJXT1000
尺寸 / SIZE (MM)



功率 / Power
10W
光束角 / Beam angle
180°
色温 / CCT
3000K/4000K/5000K

UNS-GJXT2000
尺寸 / SIZE (MM)



功率 / Power
20W
光束角 / Beam angle
180°
色温 / CCT
3000K/4000K/5000K

UNS-GJXT3000
尺寸 / SIZE (MM)



功率 / Power
30W
光束角 / Beam angle
180°
色温 / CCT
3000K/4000K/5000K

灯体颜色 / Light Color

颜色 / Color

通用规格 / General specifications

灯体材料 / Material	硅胶 / Silica gel
扩散器材料 / Diffuser	硅胶 / Silica gel
防护等级 / IP	IP20
工作温度 / Warranty	-25° C - 50° C
质保 / Warranty	5 YEARS
电压 / Voltage	24V



金属棒 - 泛光灯
STICK - FLOODLIGHT

UNS-SS300F
尺寸 / SIZE (MM)



功率 / Power
9W
光束角 / Beam angle
24°
色温 / CCT
3000K/4000K/5000K

UNS-SS600F
尺寸 / SIZE (MM)



功率 / Power
18W
光束角 / Beam angle
24°
色温 / CCT
3000K/4000K/5000K

UNS-SS900F
尺寸 / SIZE (MM)



功率 / Power
27W
光束角 / Beam angle
24°
色温 / CCT
3000K/4000K/5000K

灯体颜色 / Light Color

颜色 / Color

通用规格 / General specifications

灯体材料 / Material	铝材 / Aluminum
扩散器材料 / Diffuser	透镜 / Lens
防护等级 / IP	IP20
工作温度 / Warranty	-25° C - 50° C
质保 / Warranty	5 YEARS
电压 / Voltage	24V

ERDU®

轨道蓝牙音响

Track Bluetooth speaker



35

ERDU®



轨道蓝牙音响
TRACK BLUETOOTH SPEAKER

UNS-300300
尺寸 / SIZE (MM)



功率 / Power	10W
电压 / Voltage	DC4V-48V/AC85V-265V
蓝牙版本 / Bluetooth Version	V4.4
信号频率 / Signal Frequency	120B
主副机距离 / Distance Between Host & Sub Unit	20米无障碍 / 20 meters barrier-free
材质 / Material	PC
防护等级 / Protection class	IP20
使用环境温度 / Ambient temperature	-20 °C-40C

Bluetooth® Speaker

36

ERDU®

ERDU®

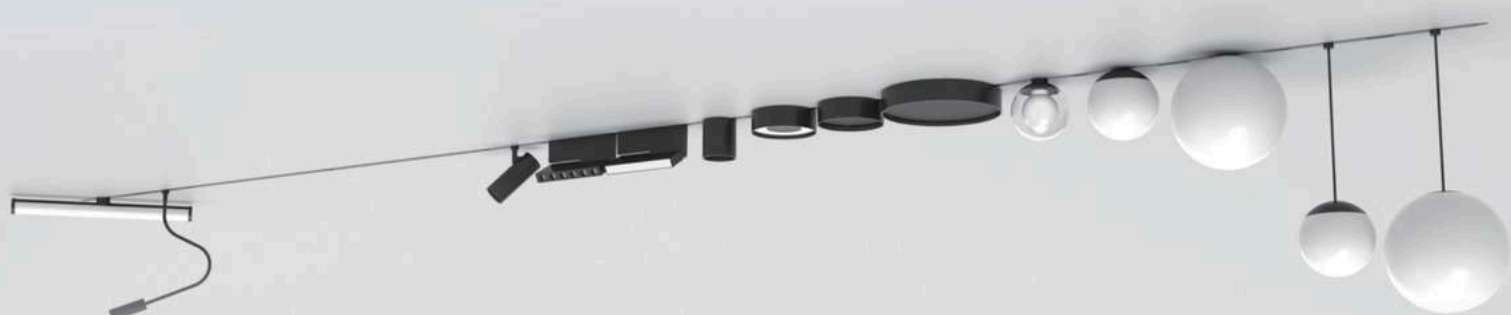

5mm宽度 超窄轨道系列
Ultra-narrow magnetic track system
5mm wide

ERDU®

ERDU®

5mm宽度 超窄轨道系列
Ultra-narrow magnetic track system

5mm wide



ERDU®



吊装轨道条 | Hanging-track

型号 | Model
UHS-C

用途 | Use
明装或悬挂 | Surface mounted or Hanging

材质 | Material
铝材 | Aluminum product

颜色 | Body Color
黑色 | Black

电压 | Voltage
DC24V

功率 | Power
200w (MAX)

防护等级 | Protection class
IP20

使用环境温度 | Ambient temperature
-30°C-40°C









规格 | Size
1000*10.8*19mm
2000*10.8*19mm
3000*10.8*19mm



ERDU®



搭配零件 | Matching parts

常规配置 Conventional configuration	 轨道末端堵头 Track end plug	 轨道防尘罩 Track dust cover	 吊线包 Hanging wire package
轨道拼接件 Track splicing components	 轨道拼接件 Track connect components		
轨道转角模块 Track angle module	 水平角接 Horizontal Angle	 垂直角接 Vertical Angle	
轨道导电模块 Track conducting module	 双头对接&双头直插 Bidirectional conductive module	 输入模块 Input module	



嵌入式暗装轨道条 | Recessed track

型号 | Model
UN5-D

用途 | Use
嵌入式 | Recessed

材质 | Material
铝材 | Aluminum product

颜色 | Body Color
黑色 | Black

电压 | Voltage
DC24V

功率 | Power
200w (MAX)

防护等级 | Protection class
IP20

使用环境温度 | Ambient temperature
-30°C-40°C

规格 | Size
1000*38*19mm
2000*38*19mm
3000*38*19mm

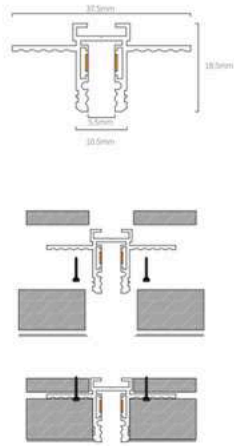

搭配零件 | Matching parts

常规配置 Conventional configuration	 轨道末端堵头 Track end plug	 轨道防尘罩 Track dust cover
轨道拼接件 Track splicing components	 轨道拼接件 Track connect components	
轨道转角模块 Track angle module	 水平角接 Horizontal Angle	 垂直角接 Vertical Angle
轨道导电模块 Track conducting module	 双头双接&双头直接 Bidirectional conductive module	 输入模块 Input module

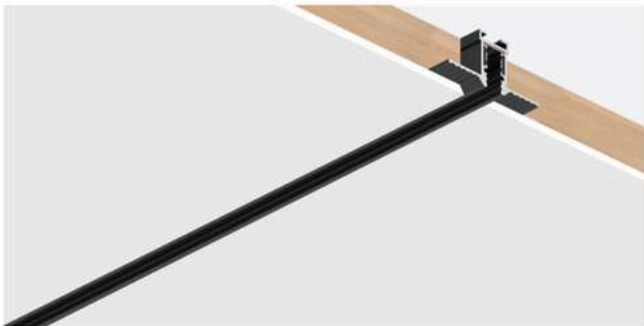

批灰轨道条 | Batch ash track

型号 | Model
UNSE-E

用途 | Use
嵌入式 | Recessed

材质 | Material
铝材 | Aluminum product

颜色 | Body Color
黑色 | Black

电压 | Voltage
DC24V

功率 | Power
200w (MAX)

防护等级 | Protection class
IP20

使用环境温度 | Ambient temperature
-30°C-40°C

规格 | Size
1000*38*19mm
2000*38*19mm
3000*38*19mm

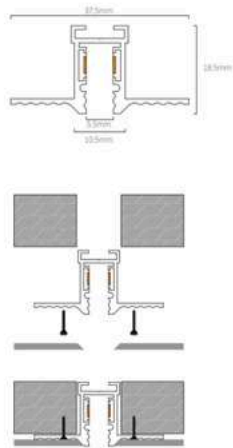

搭配零件 | Matching parts

常规配置 Conventional configuration		
轨道拼接件 Track splicing components		
轨道转角模块 Track angle module		
轨道导电模块 Track conducting module		



圆形吊装轨道 | Circular lifting track

型号 | Model
UN5-0

用途 | Use
悬挂 | Hanging

材质 | Material
铝材 | Aluminum product

颜色 | Body Color
黑色 | Black

电压 | Voltage
DC24V

功率 | Power
200w (MAX)

防护等级 | Protection class
IP20

使用环境温度 | Ambient temperature
-30°C-40°C

规格 | Size
1000*22*18mm
2000*22*18mm
3000*22*18mm

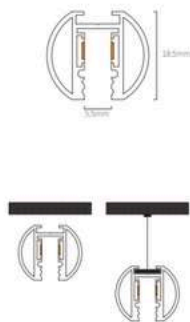

搭配零件 | Matching parts

<p>常规配置 Conventional configuration</p>	<p>轨道末端堵头 Track end plug</p>	<p>轨道防尘罩 Track dust cover</p>	<p>吊线包 Hanging wire package</p>
<p>轨道拼接件 Track splicing components</p>	<p>轨道拼接件 Track connect components</p>		
<p>轨道转角模块 Track angle module</p>	<p>水平角槽 Horizontal Angle</p>		
<p>轨道导电模块 Track conducting module</p>	<p>双向导电接点/双向直插 Bidirectional conductive module</p>	<p>输入模块 Input module</p>	

ERDU®



双面吊装轨道 | Double sided lifting track

型号 | Model
UN5-H

用途 | Use
悬挂 | Hanging

材质 | Material
铝材 | Aluminum product

颜色 | Body Color
黑色 | Black

电压 | Voltage
DC24V

功率 | Power
200w (MAX)

防护等级 | Protection class
IP20

使用环境温度 | Ambient temperature
-30°C-40°C

规格 | Size

1000*11*33mm	
2000*11*33mm	
3000*11*33mm	

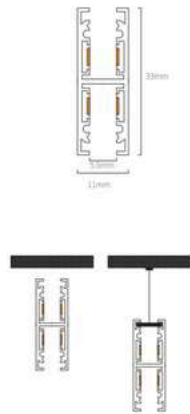

ERDU®



搭配零件 | Matching parts

常规配置 Conventional configuration			
	轨道末端堵头 Track end plug	轨道防尘罩 Track dust cover	吊线包 Hanging wire package
轨道拼接件 Track splicing components			
	轨道拼接件 Track connect components		
轨道转角模块 Track angle module			
	水平角槽 Horizontal Angle		
轨道导电模块 Track conducting module			
	双向导电模块 Bidirectional conductive module	输入模块 Input module	



超薄软膜天花轨道条 | Ceiling soft film track

型号 | Model
UN5-RM

用途 | Use
吊装固定式 | Lifting fixing

材质 | Material
铝材 | Aluminum product

颜色 | Body Color
黑色 | Black

电压 | Voltage
DC24V

功率 | Power
200w (MAX)

防护等级 | Protection class
IP20

使用环境温度 | Ambient temperature
-30°C-40°C

规格 | Size
1000*42*38mm
2000*42*38mm
3000*42*38mm

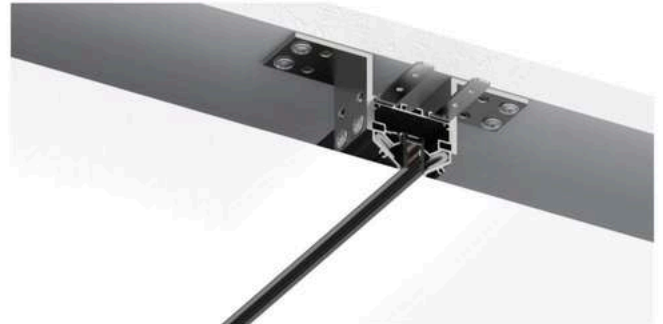
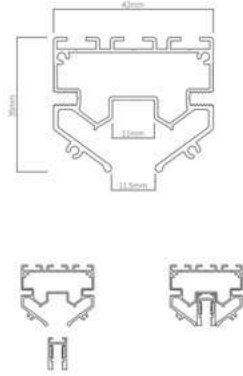

搭配零件 | Matching parts

常规配置 Conventional configuration				
	轨道末端堵头 Track end plug	固定角码 Mounting part	硅胶条 Silicone strip	吊装轨道条 Hanging track
轨道拼接件 Track splicing components				
	转角加固件 Angle reinforcement	直插加固件 Direct reinforcement		
轨道转角模块 Track angle module				
	水平角插 Horizontal Angle			
轨道导电模块 Track conducting module				
	双向导电插板 Bidirectional conductive module	输入模块 Input module		



双头软接&双头直接 | Bidirectional conductive module

型号 | Model
UN5-RJ

用途 | Use
直型或转角双向导电模块 | Type I or Angle bidirectional conductive module

材质 | Material
塑料 | plastic

颜色 | Body Color
黑色 | Black

电压 | Voltage
DC24V

功率 | Power
200w (MAX)

防护等级 | Protection class
IP20

使用环境温度 | Ambient temperature
-20°C-40°C

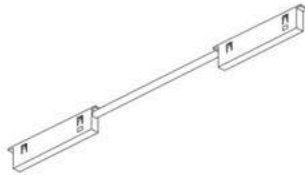

输入模块 | Input module

型号 | Model
UN5-SRMK

用途 | Use
线末端接外置变压器 | The end of the line is connected to the external transformer

材质 | Material
塑料 | plastic

颜色 | Body Color
黑色 | Black

电压 | Voltage
DC24V

功率 | Power
200w (MAX)

防护等级 | Protection class
IP20

使用环境温度 | Ambient temperature
-20°C-40°C

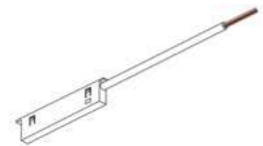

ERDU®

3 CCT

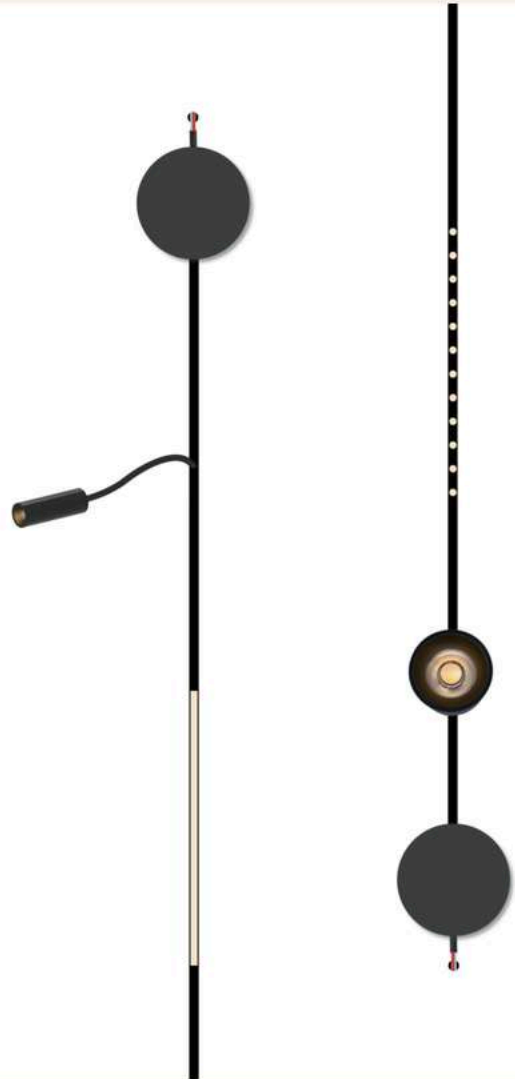
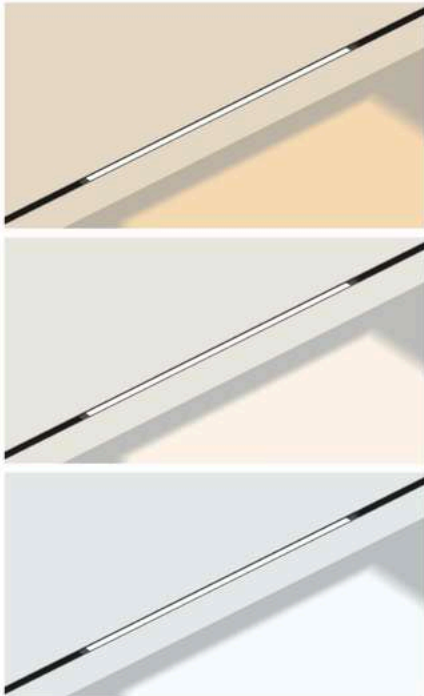

ERDU®



单色温灯具常规接线
Conventional wiring of monochrome temperature lamps

单色灯具-一体电源 | Monochrome lamps - integrated power supply



单色温灯具-可控硅, 0-10V, DALI群组控制调光接线
Monochrome temperature luminaires - TRAIC, 0-10V, DALI group control dimming wiring

单色灯具-接外置可控硅 | Monochrome lamps - Connected with external TRAIC

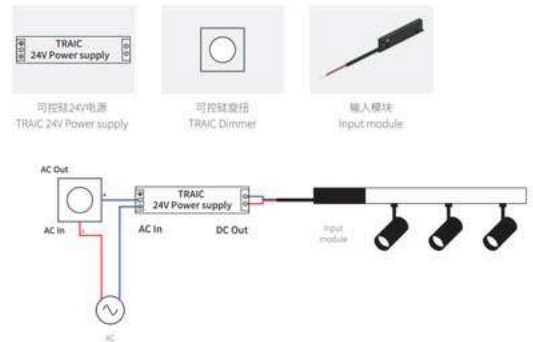

单色灯具-外接变压器 | Monochrome lamps - External transformer

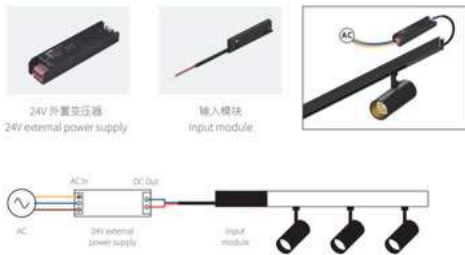

单色灯具-接外置0-10V | Monochrome lamps - Connected with external 0-10V Dimming

单色灯具-接外置DALI | Monochrome lamps - Connected with external DALI Dimming

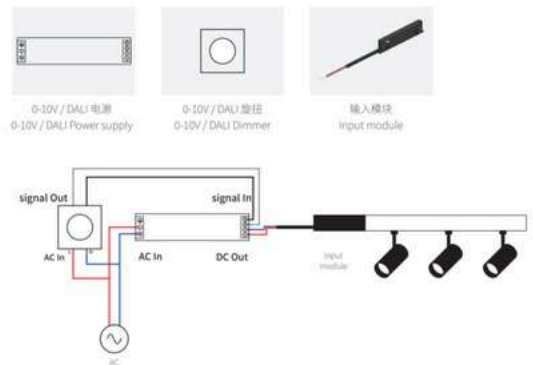



双色温灯具内置智能电源群组控制调光调色温
3CCT lamps built-in intelligent power group control dimming color temperature

双色灯具—体智能电源 | 3CCT luminaire - integrated intelligent power supply

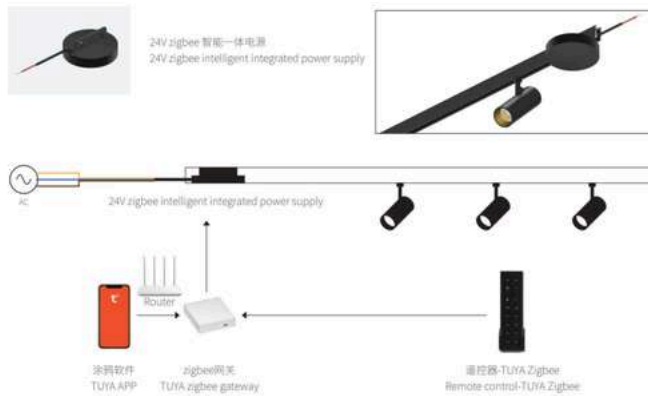

双色温灯具外置智能电源群组控制调光调色温
3CCT lamps external intelligent power supply group control dimming color temperature

双色灯具—接外置变压器和外置控制器 | 3CCT luminaire - Connect an external transformer and an external controller

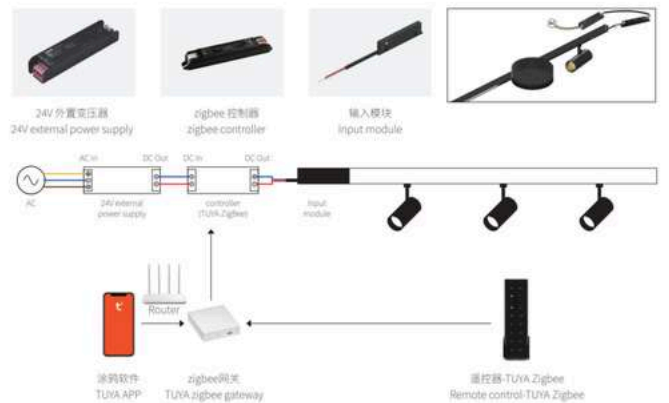

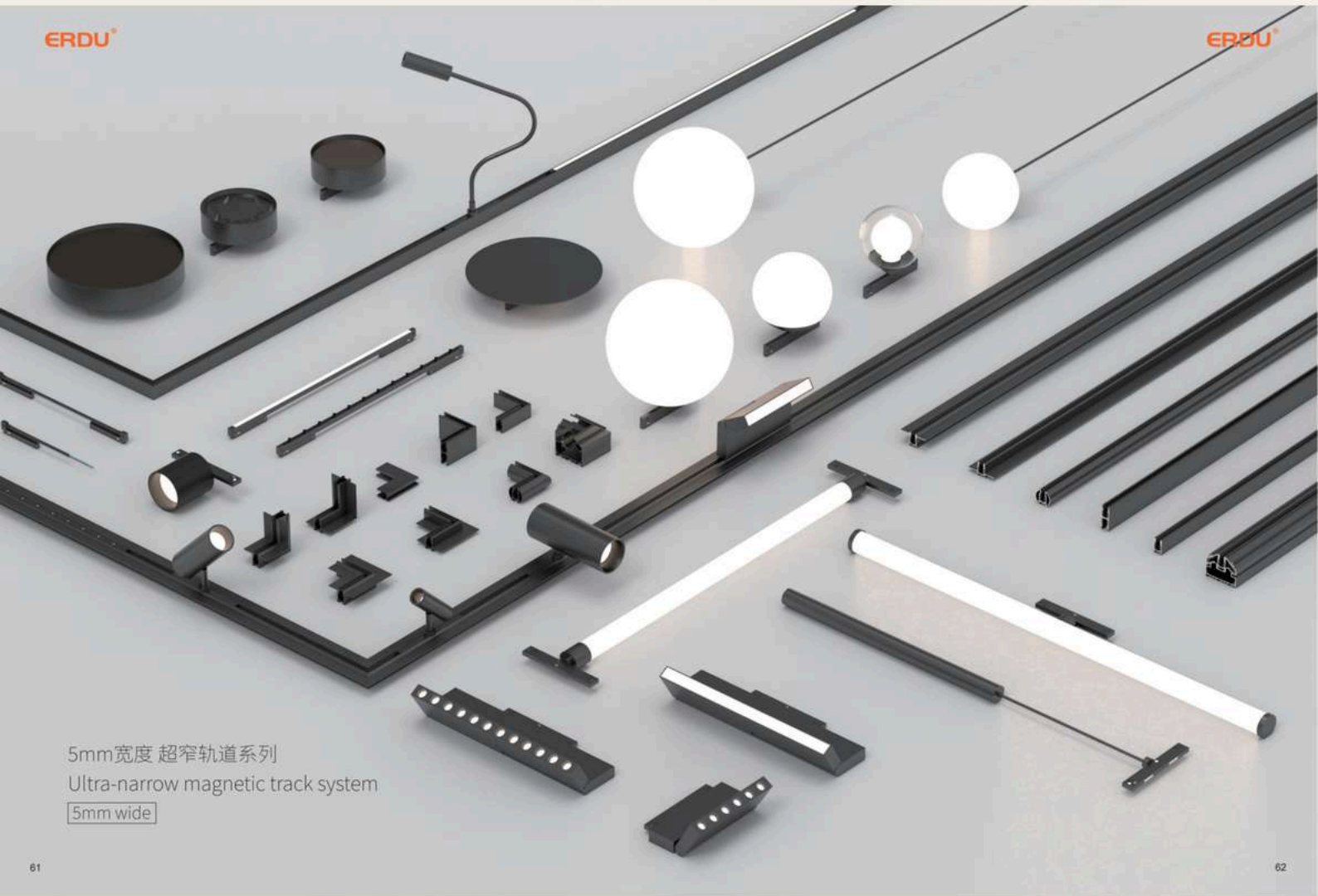

5mm宽度 超窄轨道系列
Ultra-narrow magnetic track system

5mm wide

ERDU®

ERDU®



5mm宽度 超窄轨道系列-灯具展示
Ultra-narrow magnetic track system-lamp show
5mm wide

ERDU®



线条格栅灯 | Grille light 12 in 1

型号 | Model

UN5-12T

尺寸 | size

L300*H57*H14mm

功率 | Power

9W

扩散罩 | Diffuser

透明 | lens

发光角度 | Luminous Angle

24°

色温 | Temperature

3000K / 4000K / 6000K

电压 | Voltage

DC24V

材质 | Material

铝材 | Aluminum product

颜色 | Body Color

黑色 | Black

防护等级 | Protection class

IP20

使用环境温度 | Ambient temperature

-20°C-40°C

ERDU®



ERDU®

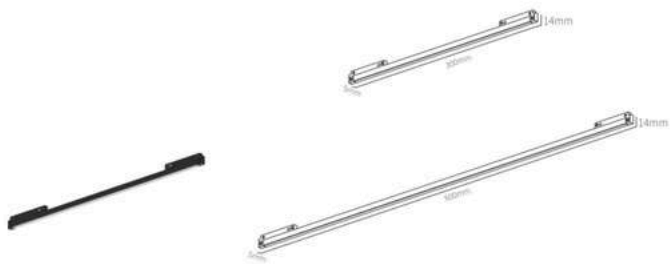

线条泛光灯 | Floodlight light

① 型号 Model UNS-300F	② 型号 Model UNS-600F
尺寸 size 1300*W5*H14mm	尺寸 size 1600*W5*H14mm
功率 Power 9W	功率 Power 18W
扩散罩 Diffuser PC	
发光角度 Luminous Angle 120°	
色温 Temperature 3000K / 4000K / 6000K	
电压 Voltage DC24V	
材质 Material 铝材 Aluminum product	
颜色 Body Color 黑色 Black	
防护等级 Protection class IP20	
使用环境温度 Ambient temperature -20°C-40°C	

ERDU®





5mm宽度 超窄轨道系列-灯具展示
Ultra-narrow magnetic track system-lamp show
5mm wide

ERDU®

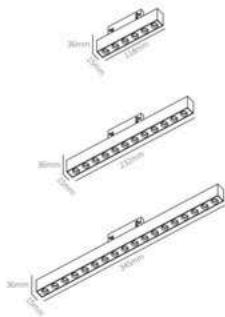

线条格栅灯 | Grille light

- | | | |
|--|---|---|
| <p>① 型号 Model
UNS-LC6T</p> <p>尺寸 size
L118*W15*H36mm</p> <p>功率 Power
6W</p> <p>扩散罩 Diffuser
透镜 lens</p> <p>发光角度 Luminous Angle
34°</p> <p>色温 Temperature
3000K / 4000K / 6000K</p> <p>电压 Voltage
DC24V</p> <p>材质 Material
铝材 Aluminum product</p> <p>颜色 Body Color
黑色 Black</p> <p>防护等级 Protection class
IP20</p> <p>使用环境温度 Ambient temperature
-20°C-40°C</p> | <p>② 型号 Model
UNS-LC12T</p> <p>尺寸 size
L232*W15*H36mm</p> <p>功率 Power
12W</p> | <p>③ 型号 Model
UNS-LC18T</p> <p>尺寸 size
L345*W15*H36mm</p> <p>功率 Power
18W</p> |
|--|---|---|

ERDU®



ERDU®



线条泛光灯 | Floodlight light

- | | | |
|---|--|--|
| <p>① 型号 Model
UNS-LC300F</p> <p>尺寸 size
L300*W15*H36mm</p> <p>功率 Power
9W</p> <p>扩散罩 Diffuser
PC</p> <p>发光角度 Luminous Angle
34°</p> <p>色温 Temperature
3000K / 4000K / 6000K</p> <p>电压 Voltage
DC24V</p> <p>材质 Material
铝材 Aluminum product</p> <p>颜色 Body Color
黑色 Black</p> <p>防护等级 Protection class
IP20</p> <p>使用环境温度 Ambient temperature
-20°C-40°C</p> | <p>② 型号 Model
UNS-LC600F</p> <p>尺寸 size
L600*W15*H36mm</p> <p>功率 Power
18W</p> | <p>③ 型号 Model
UNS-LC900F</p> <p>尺寸 size
L900*W15*H36mm</p> <p>功率 Power
27W</p> |
|---|--|--|

ERDU®

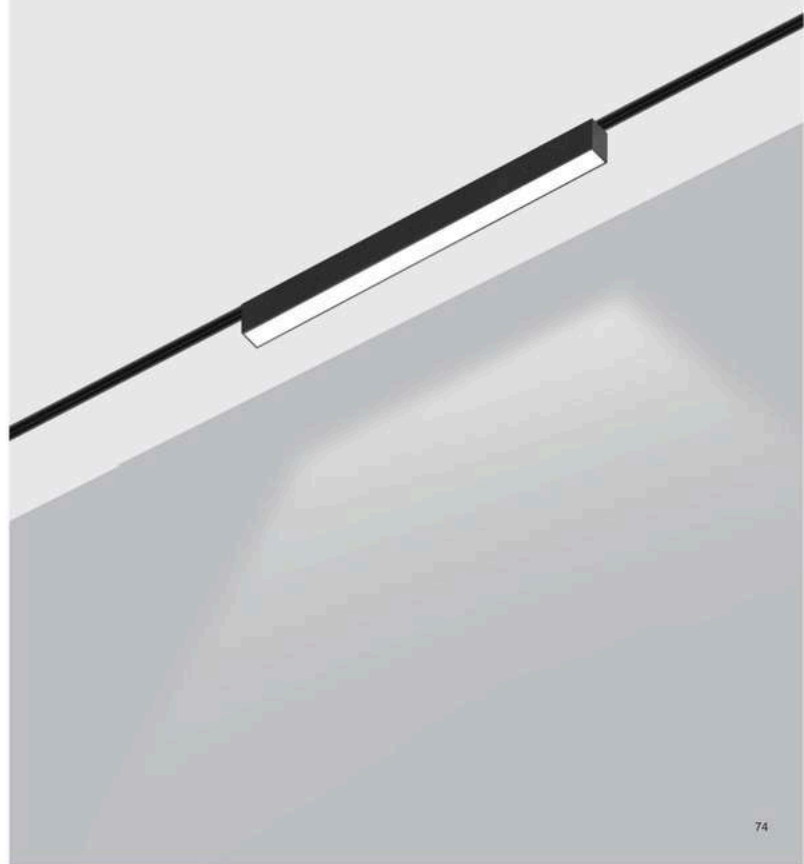

ERDU®

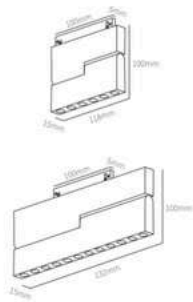

折叠格栅灯 | Folding light

- | | |
|---|---|
| <p>1 型号 Model
UN5-ZD-6T</p> <p>尺寸 size
L118*W15*H20mm</p> <p>功率 Power
6W</p> <p>扩散罩 Diffuser
lens</p> <p>发光角度 Luminous Angle
24°</p> <p>色温 Temperature
3000K / 4000K / 6000K</p> <p>电压 Voltage
DC24V</p> <p>材质 Material
铝材 Aluminum product</p> <p>颜色 Body Color
黑色 Black</p> <p>防护等级 Protection class
IP20</p> <p>使用环境温度 Ambient temperature
-20°C-40°C</p> | <p>2 型号 Model
UN5-ZD-12T</p> <p>尺寸 size
L132*W15*H20mm</p> <p>功率 Power
12W</p> |
|---|---|

ERDU®

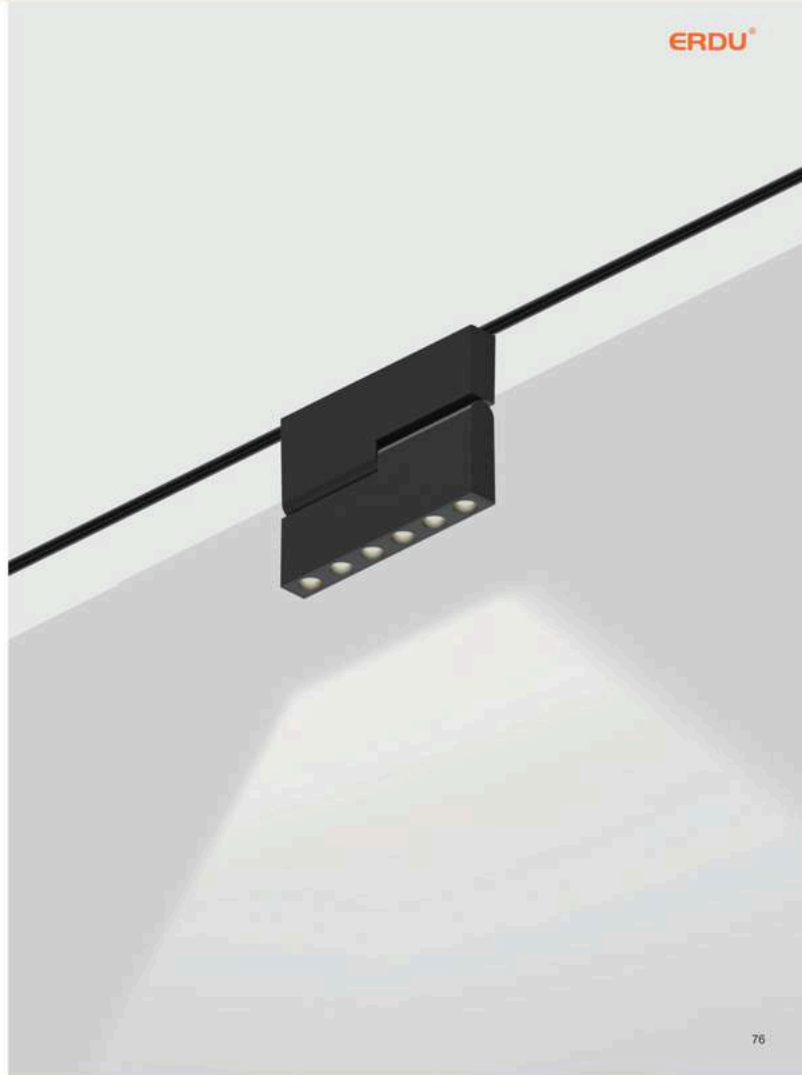

ERDU®

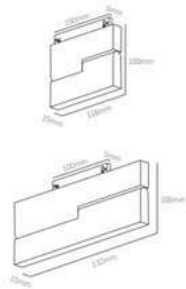

折叠泛光灯 | Floodlight Folding light

- | | |
|---|--|
| <p>① 型号 Model
KUS-2D-4F</p> <p>尺寸 size
113*15*132mm</p> <p>功率 Power
6W</p> <p>扩散罩 Diffuser
PC</p> <p>发光角度 Luminous Angle
120°</p> <p>色温 Temperature
3000K / 4000K / 6000K</p> <p>电压 Voltage
DC34V</p> <p>材质 Material
铝材 Aluminum product</p> <p>颜色 Body Color
r黑色 Black</p> <p>防护等级 Protection class
IP20</p> <p>使用环境温度 Ambient temperature
20°C-40°C</p> | <p>② 型号 Model
UNS-2D-12F</p> <p>尺寸 size
132*15*132mm</p> <p>功率 Power
12W</p> |
|---|--|

ERDU®



ERDU®

ERDU®



5mm宽度 超窄轨道系列-灯具展示
Ultra-narrow magnetic track system-lamp show
5mm wide

ERDU®



轨道射灯 | Track Lights

- | | | |
|---|---|--|
| <p>① 型号 Model
UNS-L20</p> <p>尺寸 size
Ø20*160mm</p> <p>功率 Power
3W</p> <p>扩散罩 Diffuser
lens</p> <p>发光角度 Luminous Angle
24°</p> <p>色温 Temperature
3000K / 4000K / 6000K</p> <p>电压 Voltage
DC24V</p> <p>材质 Material
铝材 Aluminum product</p> <p>颜色 Body Color
黑色 Black</p> <p>防护等级 Protection class
IP20</p> <p>使用环境温度 Ambient temperature
-20°C-40°C</p> | <p>② 型号 Model
UNS-L33</p> <p>尺寸 size
Ø33*185mm</p> <p>功率 Power
6W</p> | <p>③ 型号 Model
UNS-L43</p> <p>尺寸 size
Ø43*110mm</p> <p>功率 Power
12W</p> |
|---|---|--|

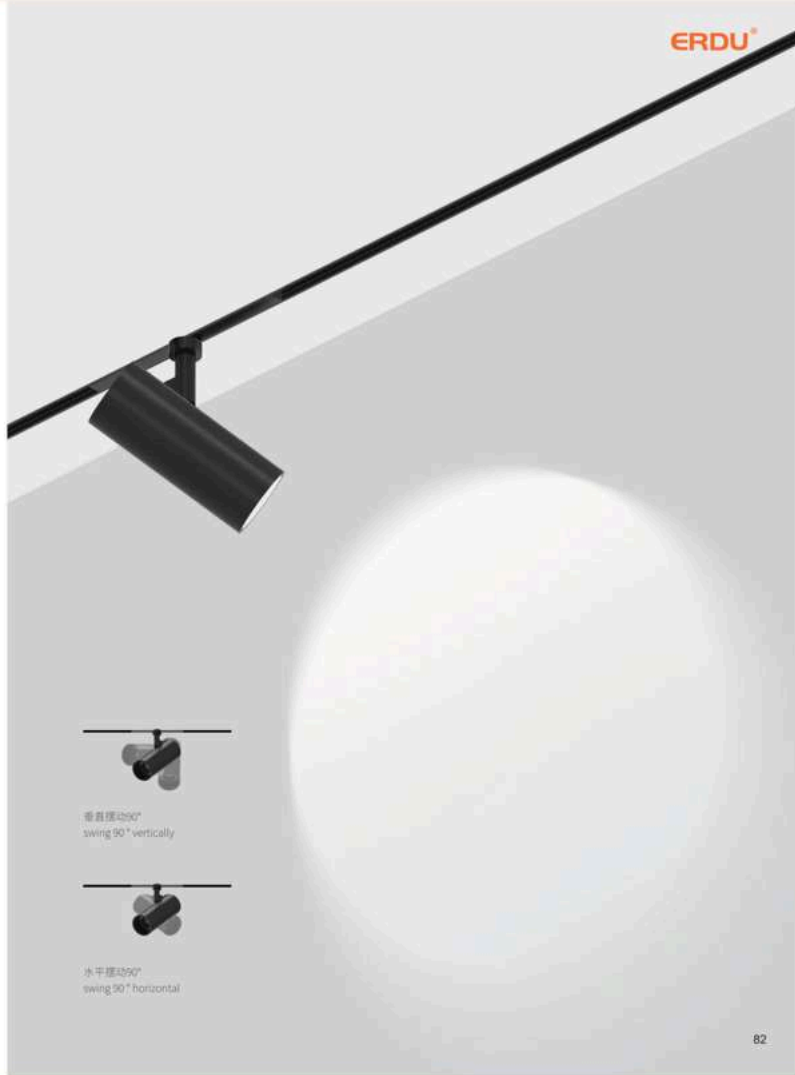

垂直摆动90°
swing 90° vertically



水平摆动90°
swing 90° horizontal

ERDU®

ERDU®



5mm宽度 超窄轨道系列-灯具展示
Ultra-narrow magnetic track system-lamp show
5mm wide

ERDU®



轨道式阅读灯 | Track type reading light

型号 | Model
UN5-YDL20

尺寸 | size
Ø20*160mm

功率 | Power
3W

扩散罩 | Diffuser
lens

发光角度 | Luminous Angle
24°

色温 | Temperature
3000K / 4000K / 6000K

电压 | Voltage
DC24V

材质 | Material
铝材 | Aluminum product

颜色 | Body Color
黑色 | Black

防护等级 | Protection class
IP20

使用环境温度 | Ambient temperature
-20°C-40°C

ERDU®



ERDU®



明装圆形射灯 | Surface mounted spotlights

型号 | Model
UN5-TD50

尺寸 | size
Ø50*H57mm

功率 | Power
6W

扩散罩 | Diffuser
lens

发光角度 | Luminous Angle
24°

色温 | Temperature
3000K / 4000K / 6000K

电压 | Voltage
DC24V

材质 | Material
铝材 | Aluminum product

颜色 | Body Color
黑色 | Black

防护等级 | Protection class
IP20

使用环境温度 | Ambient temperature
-20°C-40°C

ERDU®



ERDU®



明装圆形射灯 | Surface mounted spotlights 9 in 1

型号 | Model
UNS-G90

尺寸 | size
Ø95*30mm

功率 | Power
9W

扩散罩 | Diffuser
lens

发光角度 | Luminous Angle
24°

色温 | Temperature
3000K / 4000K / 6000K

电压 | Voltage
DC24V

材质 | Material
铝材 | Aluminum product

颜色 | Body Color
黑色 | Black

防护等级 | Protection class
IP20

使用环境温度 | Ambient temperature
-20°C-40°C

ERDU®



ERDU®

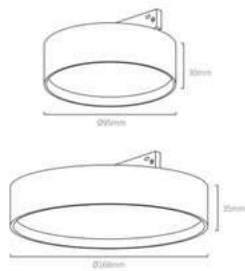

明装泛光灯 | Surface mounted - floodlight

- | | |
|---|---|
| <p>① 型号 Model
UNS-WB90</p> <p>尺寸 size
Ø95*H30mm</p> <p>功率 Power
9W</p> <p>扩散罩 Diffuser
PC</p> <p>发光角度 Luminous Angle
120°</p> <p>色温 Temperature
3000K / 4000K / 6000K</p> <p>电压 Voltage
DC24V</p> <p>材质 Material
铝材 Aluminum product</p> <p>颜色 Body Color
黑色 Black</p> <p>防护等级 Protection class
IP20</p> <p>使用环境温度 Ambient temperature
-20°C-40°C</p> | <p>② 型号 Model
UNS-WB158</p> <p>尺寸 size
Ø158*H35</p> <p>功率 Power
18W</p> |
|---|---|

ERDU®

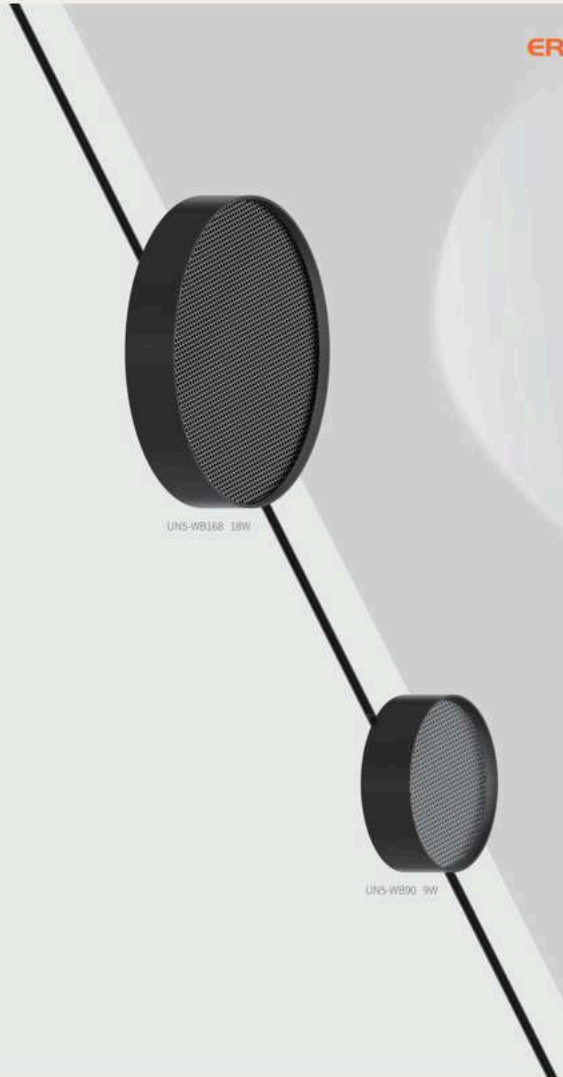

ERDU®

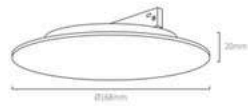

日蚀壁灯 | Solar eclipse Wall lamp

型号 | Model

UNS-YS60

尺寸 | size

Ø168x20mm

功率 | Power

9W

扩散罩 | Diffuser

PC

发光角度 | Luminous Angle

150°

色温 | Temperature

3000K / 4000K / 6000K

电压 | Voltage

DC24V

材质 | Material

铝材 | Aluminum product

颜色 | Body Color

黑色 | Black

防护等级 | Protection class

IP20

使用环境温度 | Ambient temperature

-20°C-40°C

ERDU®

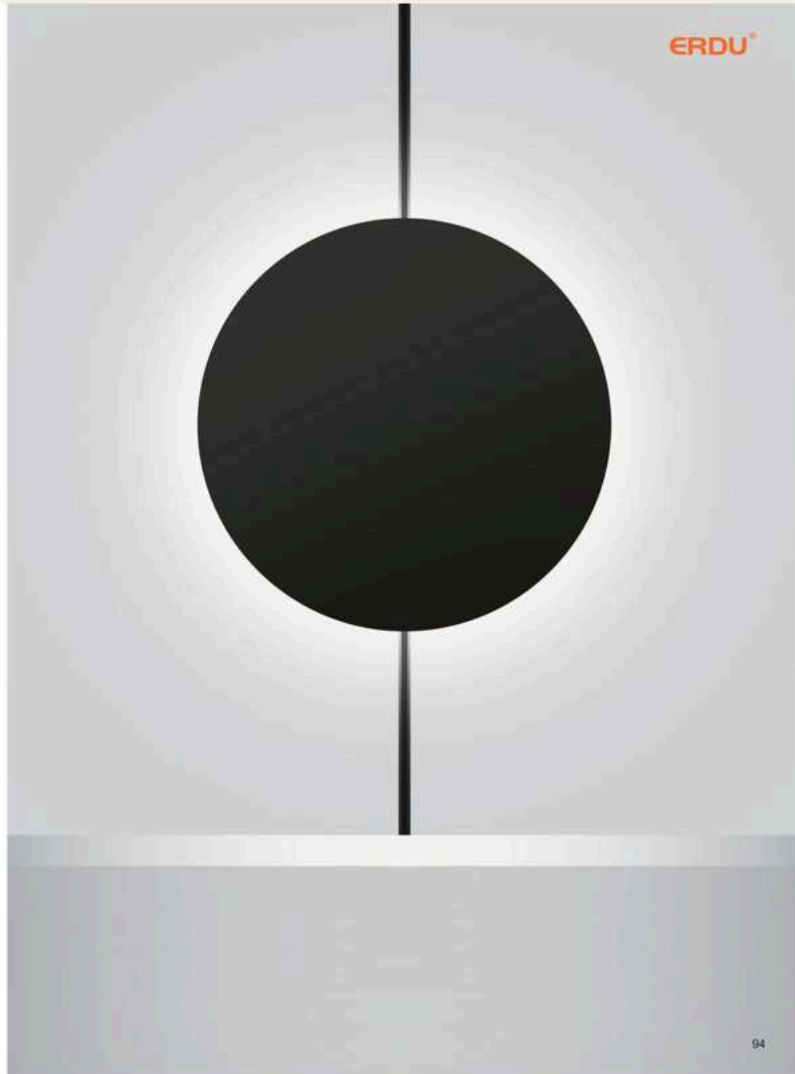

ERDU®

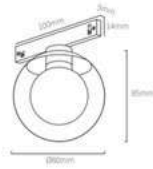

双层玻璃球装饰灯 | Frosted Glass Ball

型号 | Model
UN5-880

尺寸 | size
Ø80*H85mm

功率 | Power
6W

扩散罩 | Diffuser
玻璃 | glass

发光角度 | Luminous Angle
150°

色温 | Temperature
3000K / 4000K / 6000K

电压 | Voltage
DC24V

材质 | Material
铝材 | Aluminum product

颜色 | Body Color
黑色 | Black

防护等级 | Protection class
IP20

使用环境温度 | Ambient temperature
-20°C-40°C

ERDU®



ERDU®

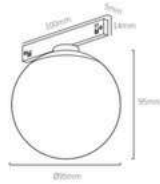

圆球灯 | track ball lamp

型号 | Model
UN5-F35

尺寸 | size
Ø80*105mm

功率 | Power
6W

扩散罩 | Diffuser
PC

发光角度 | Luminous Angle
180°

色温 | Temperature
3000K / 4000K / 6000K

电压 | Voltage
DC24V

材质 | Material
铝材 | Aluminum product

颜色 | Body Color
黑色 | Black

防护等级 | Protection class
IP20

使用环境温度 | Ambient temperature
-20°C-40°C

ERDU®



ERDU®

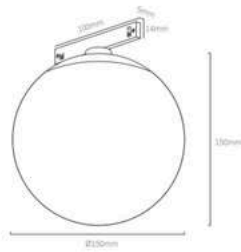

轨道式-地球(月球) | Track type -Earth(Moon)

- | | |
|--|--|
| <p>① 型号 Model
UN5-GDB150</p> <p>尺寸 size
Ø150*H150mm</p> <p>功率 Power
6W</p> <p>扩散器 Diffuser
塑料 plastic</p> <p>发光角度 Luminous Angle
35°</p> <p>色温 Temperature
3000K / 4000K / 6000K</p> <p>电压 Voltage
DC24V</p> <p>材质 Material
铝材 Aluminum product</p> <p>颜色 Body Color
黑色 Black</p> <p>防护等级 Protection class
IP20</p> <p>使用环境温度 Ambient temperature
-20°C-40°C</p> | <p>② 型号 Model
UN5-GDY150</p> <p>尺寸 size
Ø150*H150mm</p> <p>功率 Power
6W</p> |
|--|--|

ERDU®



ERDU®

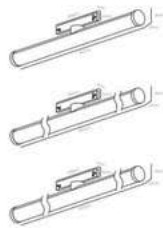

金刚棒-泛光灯 | Stick - floodlight

1 型号 Model UNS-SS300F	2 型号 Model UNS-SS600F	3 型号 Model UNS-SS900F
尺寸 size L300xW25xH130mm	尺寸 size L600xW25xH130mm	尺寸 size L900xW25xH130mm
功率 Power 9W	功率 Power 18W	功率 Power 27W
扩散罩 Diffuser PC		
发光角度 Luminous Angle 180°		
色温 Temperature 3000K / 4000K / 6000K		
电压 Voltage DC24V		
材质 Material 铝材 Aluminum product		
颜色 Body Color 黑色 Black		
防护等级 Protection class IP20		
使用环境温度 Ambient temperature -20°C-40°C		

ERDU®



悬吊式软管-泛光 | Silicone light tube

1 型号 Model UNS-RG1000	2 型号 Model UNS-RG2000
尺寸 size Ø22"L1000mm	尺寸 size Ø22"L2000mm
功率 Power 14W	功率 Power 28W
扩散罩 Diffuser 硅胶管 Silicone tube	
发光角度 Luminous Angle 360°	
色温 Temperature 3000K / 4000K / 6000K	
电压 Voltage DC24V	
材质 Material 铝材 Aluminum product	
颜色 Body Color 黑色 Black	
防护等级 Protection class IP20	
使用环境温度 Ambient temperature -20°C-40°C	

ERDU®



直式悬吊灯 | Hoisting-Straight cylinder

型号 | Model
UHS-300300

尺寸 | size
Ø30*1300mm

功率 | Power
6W

扩散罩 | Diffuser
lens

发光角度 | Luminous Angle
24°

色温 | Temperature
3000K / 4000K / 6000K

电压 | Voltage
DC24V

材质 | Material
铝材 | Aluminum product

颜色 | Body Color
黑色 | Black

防护等级 | Protection class
IP20

使用环境温度 | Ambient temperature
-20°C-40°C

ERDU®



ERDU®



悬吊式圆球灯 | Suspended spherical lamp

型号 | Model

UNS-DF95

尺寸 | size

Ø95*165mm

功率 | Power

6W

扩散罩 | Diffuser

PC

发光角度 | Luminous Angle

180°

色温 | Temperature

3000K / 4000K / 6000K

电压 | Voltage

DC24V

材质 | Material

铝材 | Aluminum product

颜色 | Body Color

黑色 | Black

防护等级 | Protection class

IP20

使用环境温度 | Ambient temperature

-20°C-40°C



ERDU®

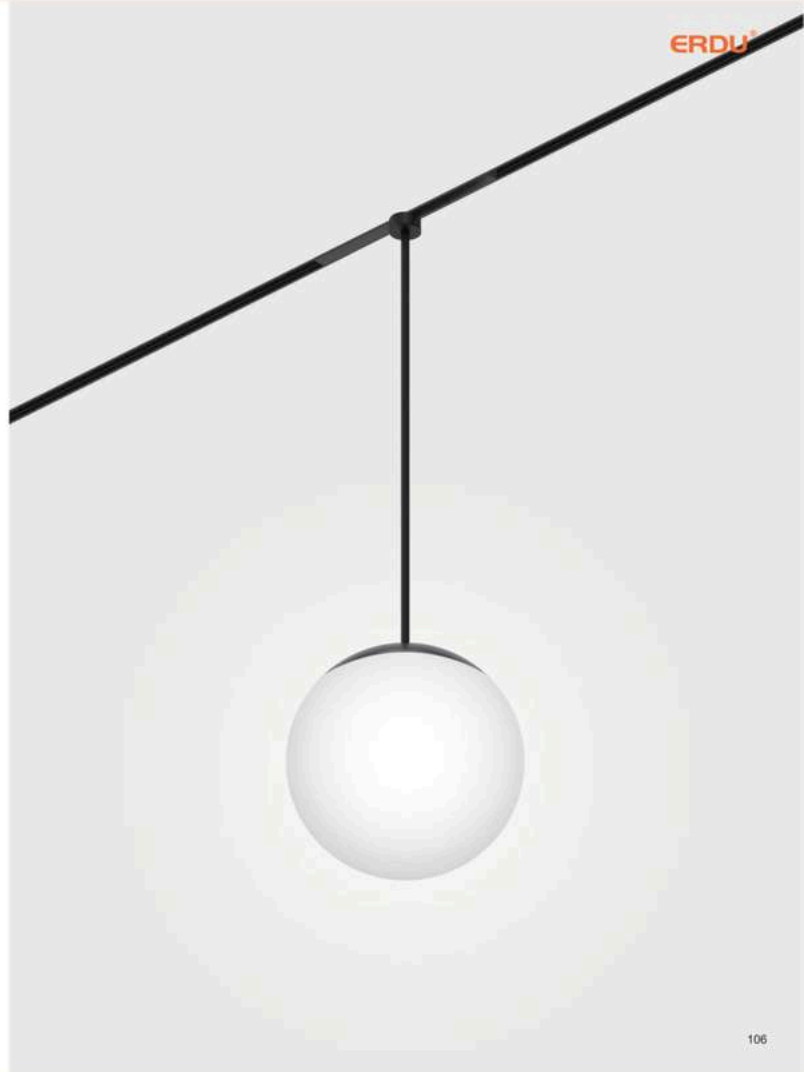

ERDU®



星球悬吊灯-地球(月球) | Planet chandelier -Earth(Moon)

- | | |
|---|---|
| <p>1 型号 Model
UN5-0150</p> <p>尺寸 size
Ø150*H150mm</p> <p>功率 Power
6W</p> <p>扩散器 Diffuser
塑料 plastic</p> <p>发光角度 Luminous Angle
35°</p> <p>色温 Temperature
3000K / 4000K / 6000K</p> <p>电压 Voltage
DC24V</p> <p>材质 Material
铝材 Aluminum product</p> <p>颜色 Body Color
黑色 Black</p> <p>防护等级 Protection class
IP20</p> <p>使用环境温度 Ambient temperature
-20°C-40°C</p> | <p>2 型号 Model
UN5-Y150</p> <p>尺寸 size
Ø150*H150mm</p> <p>功率 Power
6W</p> |
|---|---|

ERDU®





Colorful flexibility
Orbital system

109

110



炫彩系列2025
Colorful Series 2025

111

112



柔性轨道的优点体现在快速安装,可以在施工现场简单弯曲,以适应照明要求和建筑所要求的任何几何形状,可以勾勒出不同程度的曲线,自由而流畅的形状,与丰富的光性能结合在一起

The advantages of flexible tracks lie in their rapid installation and the ability to be simply bent at the construction site to fit. According to the lighting requirements and any geometric shape required by the building, it can be outlined to varying degrees. Curves, free and smooth shapes, combined with rich light performance.



多种颜色可供选择和自由搭配

A variety of colors are available for selection and free combination

- 黑色/Black
- 灰色/Gray
- 绿色/Green
- 卡其色/Khaki
- 橙色/Orange

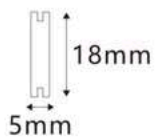

最小尺寸/Minimum dimensions

在一个最小截面中，两个铜导体与一段热塑性弹性体共挤出，但仍然完全安全地暴露在外。

一条纤细的谐波钢带沿着背面延伸，形成轮廓，并允许不同的几何形状被编织和保持。轨道变成一条可以在施工现场简单弯曲的带子，以适应由照明要求和建筑学决定的任何几何形状。

In a minimum cross-section, two copper conductors are co-extruded with a section of thermoplastic elastomer, but still Completely and safely exposed.

A slender harmonic steel band extends along the back, forming an outline and allowing different geometrics to be woven and maintained. The track becomes a band that can be simply bent at the construction site to adapt to any geometric shape determined by lighting requirements and architecture.

热塑性弹性体与铜导体正极和负极一起挤出
The thermoplastic elastomer is extruded together with the positive and negative poles of the copper conductor

ERDU®

ERDU®

可持续性

由于其材料特性，轨道可以在原位切割和折叠，最小半径为300毫米

Sustainability

Due to its material properties, the track can be cut and folded in situ with a minimum radius of 300 millimeters.

轨道交付/Track delivery

5-10-20米/卷(mroll)

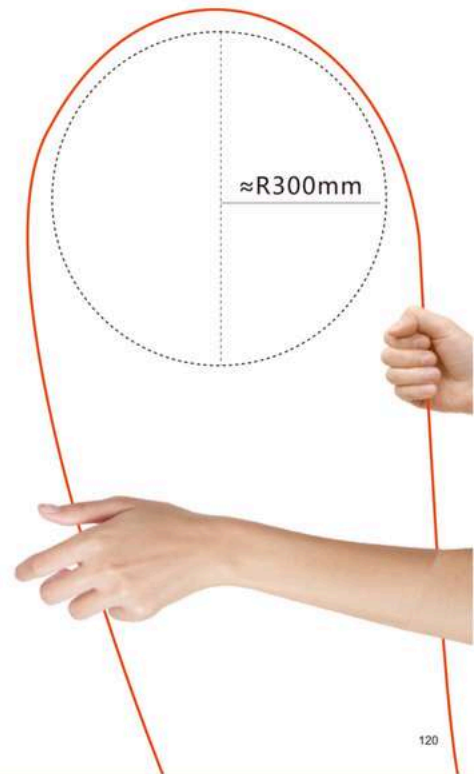
**最小曲率半径/Minimum curvature radius**



越来越多的配置, 从最小到最大的延伸,
墙壁和天花板布局的一些案例

More and more configurations, from the smallest to the largest
extensions, some cases of wall and ceiling layouts

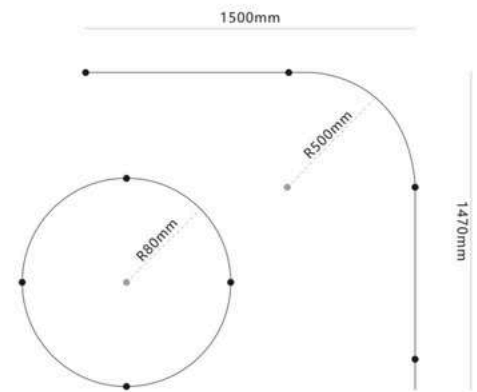
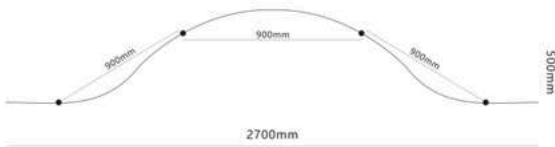
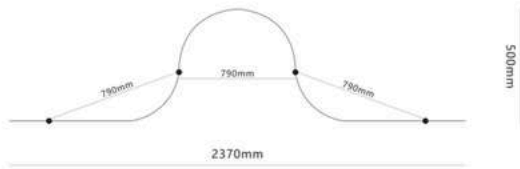



半柔轨道是一种多功能的创意性照明系统,它将轨道的概念提升到了一个新的高度。

通过不同的DIY,突出产品的艺术性,装饰性。
以导电轨道带为核心,灯具可以自由摆放,并能
在现场创造出独特的照明解决方案

The semi-flexible track is a multi-functional and creative lighting system that elevates the concept of the track Reach a new height.

Through various DIY activities, highlight the artistry and decorative nature of the products.
With the conductive track band as the core, the lamps can be freely placed and can Create unique lighting solutions on the spot

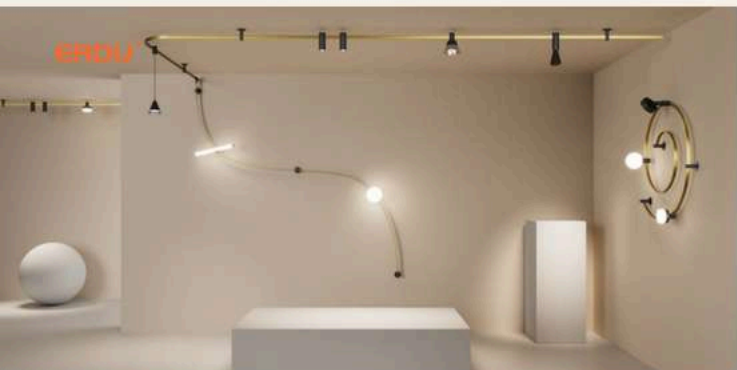

ERDU®

超薄柔性线性轨道-结合使用

根据您的需要选择您喜欢的安装方式
Ultra-thin flexible linear track - used in combination
Choose the installation method you like according to your needs

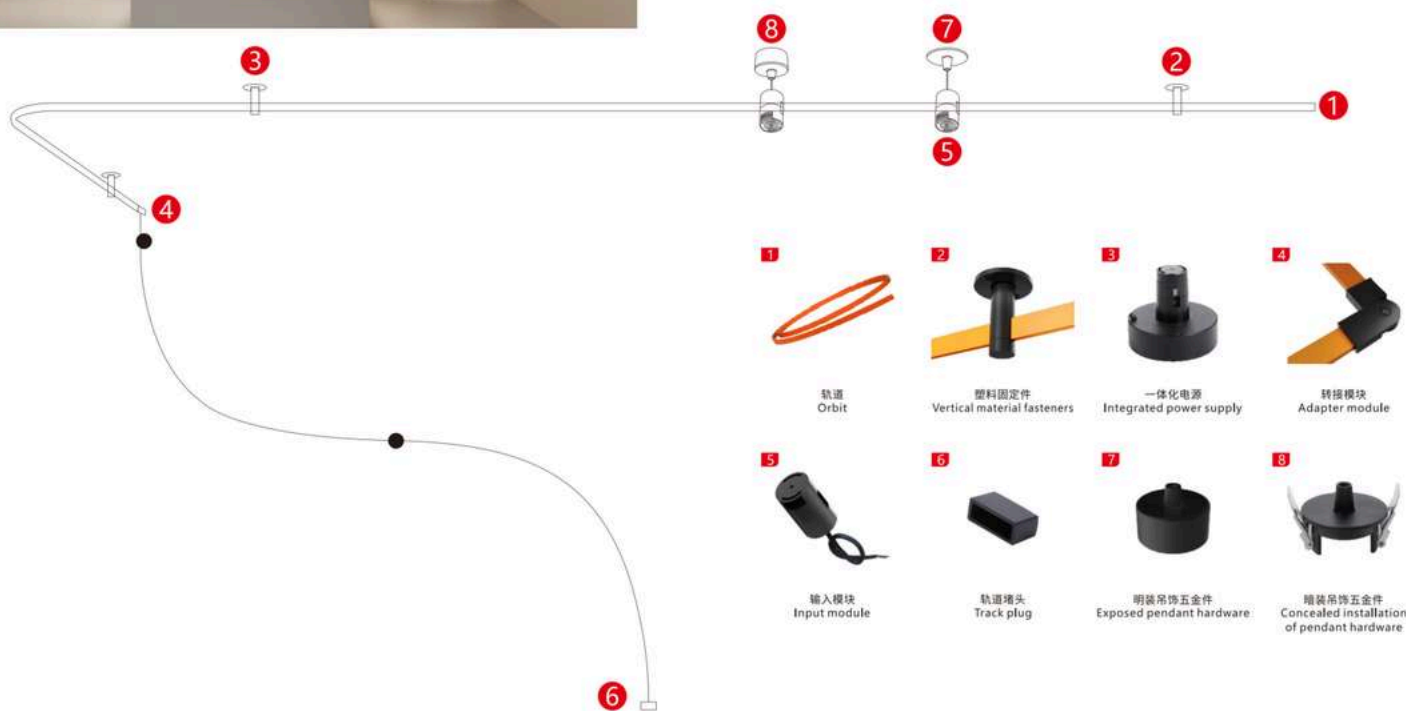



柔性轨道配件 Flexible track accessories



暗装吊饰五金件 型号/Model: BR1801
Concealed installation of pendant hardware

产品尺寸: $\Phi 60 \times H 50 \text{mm}$ Product Size: $\Phi 60 \times H 50 \text{mm}$

功能/Function

- 1. 天花板外置电源暗装隐藏线盖。 1. Concealed wire cover for external power supply on the ceiling.
- 2. 适用于天花板、墙壁安装。 2. Suitable for ceiling and wall installation.

安装步骤/Installation steps

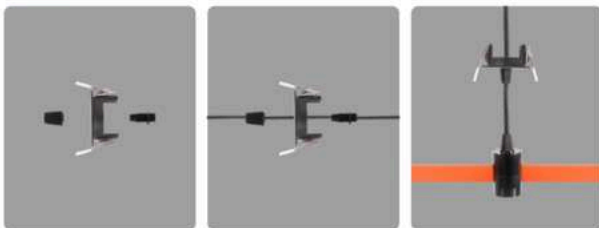

柔性轨道配件 Braided track accessories



明装吊饰五金件 型号/Model: BR1802
Exposed pendant hardware

产品尺寸: $\Phi 50 \times H 47 \text{mm}$ Product Size: $\Phi 60 \times H 50 \text{mm}$

功能/Function

- 1. 天花板明装隐藏线盖。 1. Ceiling exposed concealed wire cover.
- 2. 适用于天花板、墙壁安装。 2. Suitable for ceiling and wall installation.

安装步骤/Installation steps

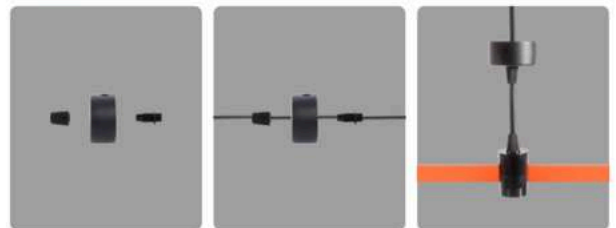



柔性轨道配件 Braided track accessories



输入模块 型号/Model: BR1803
Input module

产品尺寸: $\Phi 32 \times H 47.5 \text{mm}$ Product Size: $\Phi 32 \times H 47.5 \text{mm}$

功能/Function

- | | |
|--------------|--|
| 1. 轨道导电转换功能。 | 1. Orbital conductive conversion function. |
| 2. 轨道供电作用。 | 2. Rail power supply function. |
| 3. 搭配吊饰五金件安装 | 3. Installation of accessories and hardware. |

安装步骤/Installation steps



柔性轨道配件 Braided track accessories



塑料固定 型号/Model: BR1804
Plastic fixation

产品尺寸: $59.5 \times 20 \times 53 \text{mm}$ Product Size: $59.5 \times 20 \times 53 \text{mm}$

功能/Function

- | | |
|-----------------|--|
| 1. 半柔塑料五金轨道固定头。 | 1. Semi-flexible plastic hardware track fixing head. |
|-----------------|--|

安装步骤/Installation steps

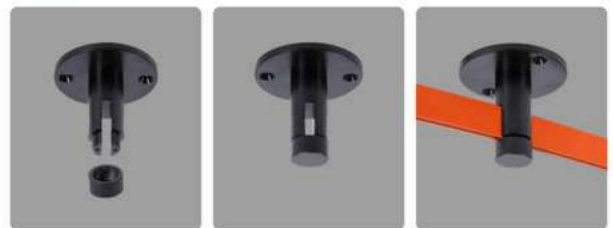



柔性轨道配件 Braided track accessories

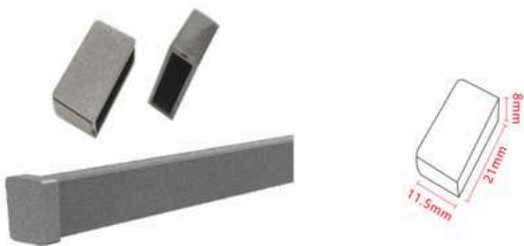

轨道堵头 型号/Model: BR1806
Track plug

产品尺寸: 21×8×11.5mm Product Size: 21×8×11.5mm

功能/Function

- | | |
|------------|------------------------|
| 1. 轨道堵头盖子。 | 1. Track plug cover. |
| 2. 装饰作用。 | 2. Aesthetic function. |

安装步骤/Installation steps

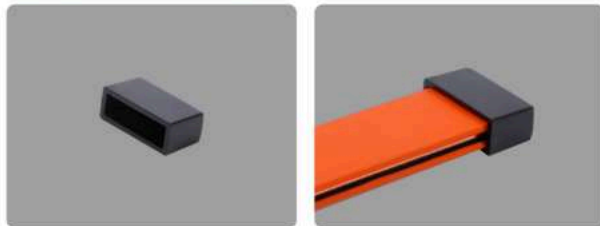

柔性轨道配件 Braided track accessories



转接模块 型号/Model: BR1807
Adapter module

产品尺寸: 62×26×12mm Product Size: 62×26×12mm

功能/Function

- | | |
|----------------|--|
| 1. 半柔轨道的五金连接件。 | 1. Hardware connectors for semi-flexible tracks. |
| 2. 改变轨道方向 | 2. Change the direction of the orbit. |

安装步骤/Installation steps

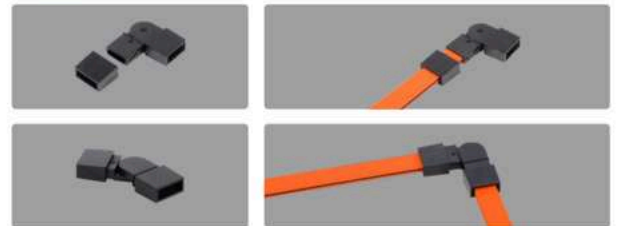



通过轨道不断地衔接创造出需要的造型, 这是很好的创意, 非常实用。

适用于商业空间

It is a great idea to continuously connect the tracks to create the required shapes, which is very practical.

Applicable to commercial Spaces

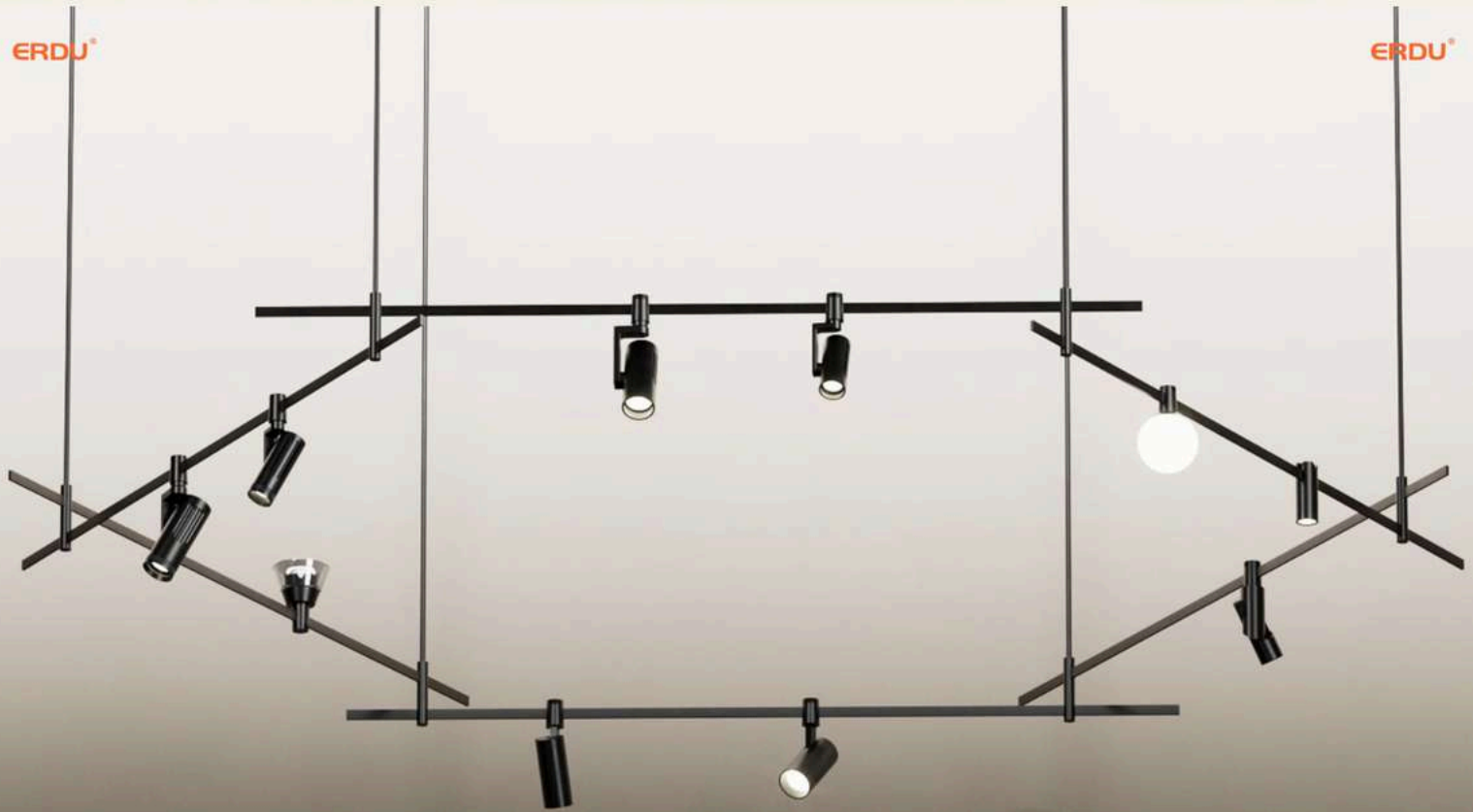

可通过轨道拼接出理想的造型, 用在每个空间
The ideal shape can be formed by splicing the tracks and used in every space



适用于休闲空间、商业空间、家庭氛围
It is suitable for leisure Spaces, commercial
Spaces and home atmospheres

137

138



ERDU®

超薄线性轨道-结合使用

根据您的需要选择您喜欢的安装方式

Ultra-thin linear track - used in combination

Choose the installation method you like according to your needs

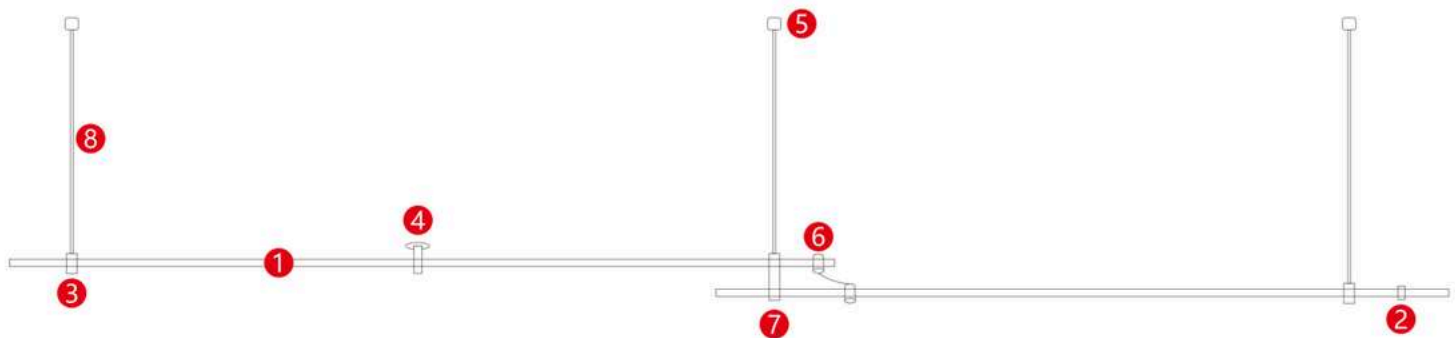

- 1**



轨道
Orbit
- 2**



轨道堵头
Track plug
- 3**



输入模块
Input module
- 4**



一体化电源
Integrated power supply
- 5**



塑料固定
Plastic fixation
- 6**



双头输入导电模块
Dual-head input conductive module
- 7**



五金双层旋转吊线杆
Double-layer rotating hanging wire rod for hardware
- 8**



五金加长杆
Hardware extension rod



■ 线性轨道配件 Linear track accessories



五金加长杆 型号/Model: WJ1801
Hardware extension rod

产品尺寸: 300/600/900mm(可定制长度)
Product Size: 300/600/900mm(The length can be customized.)

功能/Function

- 1. 天花板与轨道的五金加长杆
- 1. The hardware extension rods for the ceiling and the track.

安装步骤/Installation steps

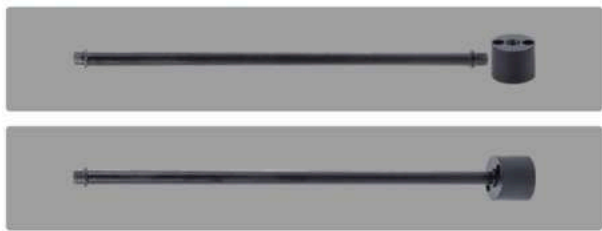

■ 线性轨道配件 Linear track accessories

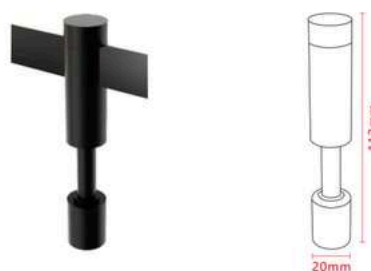

塑料固定 型号/Model: BR1805
Plastic fixation

产品尺寸: $\Phi 20 \times H112$ mm Product Size: $\Phi 20 \times H112$ mm

功能/Function

- 1. 固定轨道。
- 1. Fixed track.

安装步骤/Installation steps





■ 线性轨道配件 Linear track accessories



五金双层旋转吊线杆 型号/Model: WJ1804
Double-layer rotating hanging wire rod for hardware

产品尺寸: $\Phi 20 \times H160\text{mm}$ Product Size: $\Phi 20 \times H160\text{mm}$

功能/Function

1. 轨道与轨道拼接上下连接杆(可350°旋转)。
1. Track and track splicing upper and lower connecting rods (can be rotated 350°).

安装步骤/Installation steps



■ 线性轨道配件 Linear track accessories

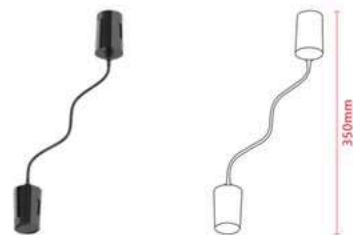

双头输入导电模块 型号/Model: WJ1805
Dual-head input conductive module

产品尺寸: 350mm Product Size: 350mm

功能/Function

1. 轨道与轨道拼接上下导电连接头。
1. Track and track splicing upper and lower conductive connection heads.
2. 轨道供电作用。
2. Rail power supply function.
3. 搭配电源器使用。
3. Use in conjunction with a power supply.

安装步骤/Installation steps



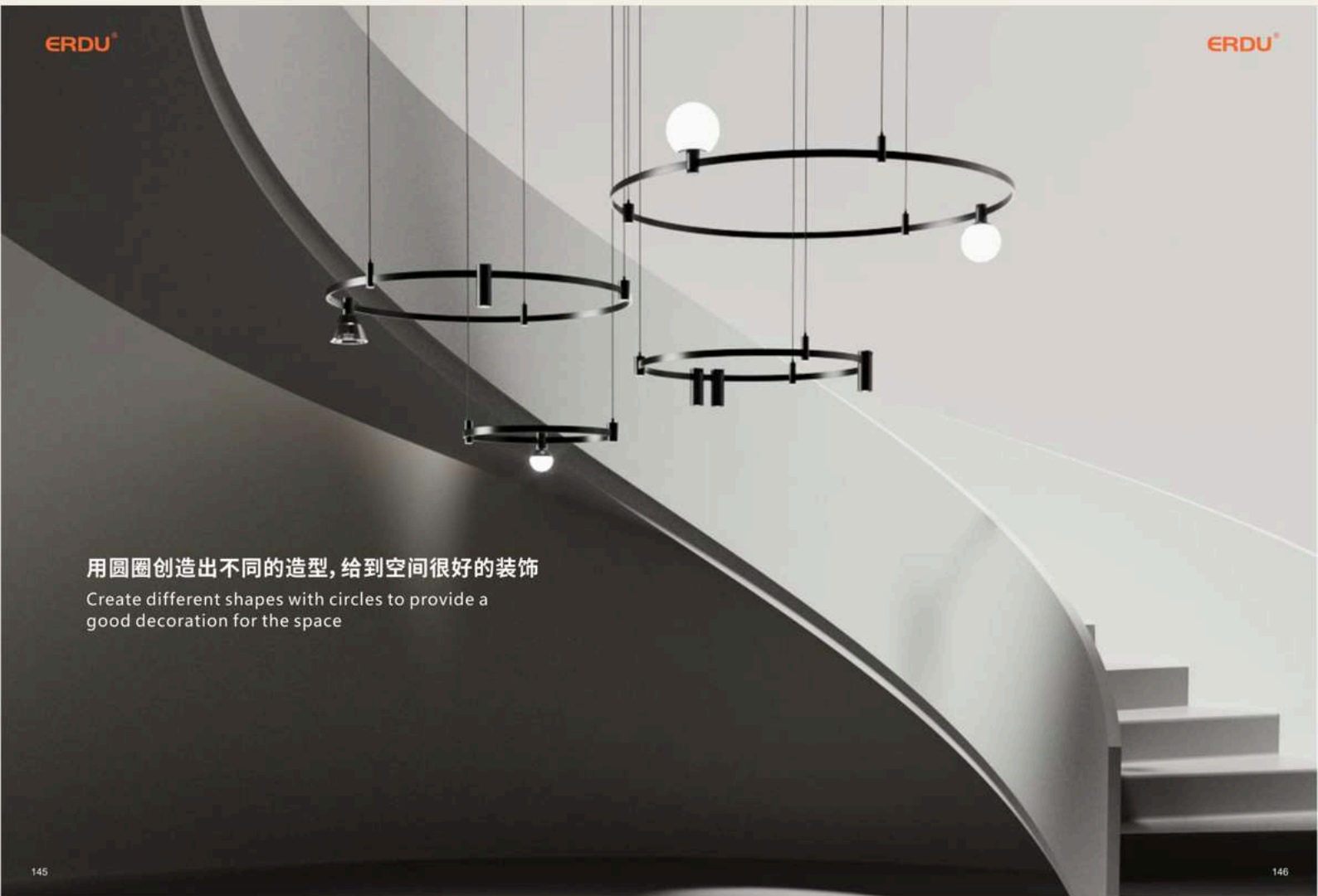

ERDU®

ERDU®

用圆圈创造出不同的造型, 给到空间很好的装饰

Create different shapes with circles to provide a good decoration for the space

145

146

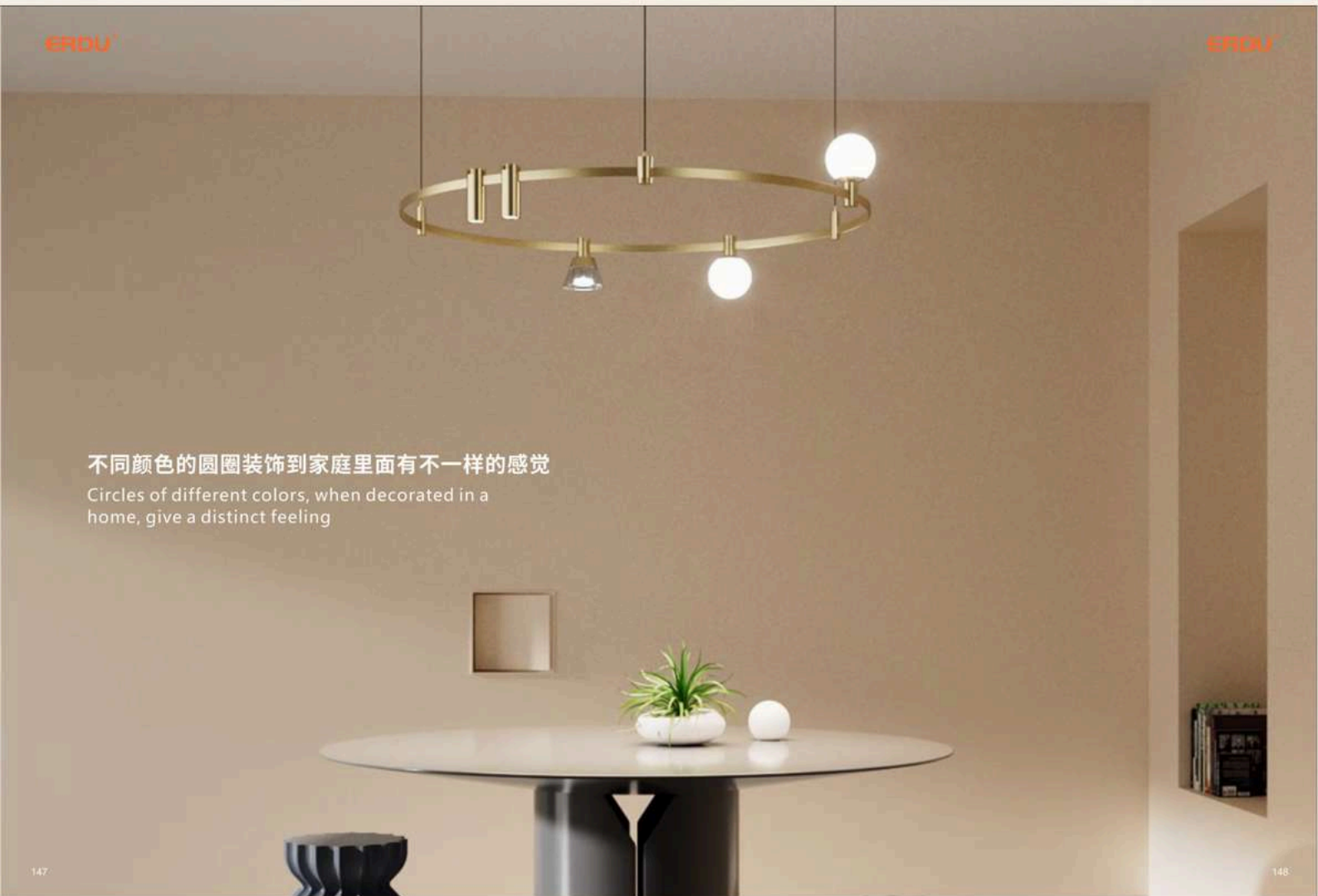

不同颜色的圆圈装饰到家庭里面有不一样的感觉
Circles of different colors, when decorated in a home, give a distinct feeling



ERDU®

ERDU®

LOUNGE

POWOER ROOM
COWTROL ROOM

圆圈碰上圆圈, 是一个不错的创意
Circles meeting circles is a good idea

149

150



超薄圆圈线性轨道-结合使用

根据您的需要选择您喜欢的安装方式

Ultra-thin circular linear track - used in combination

Choose the installation method you like according to your needs

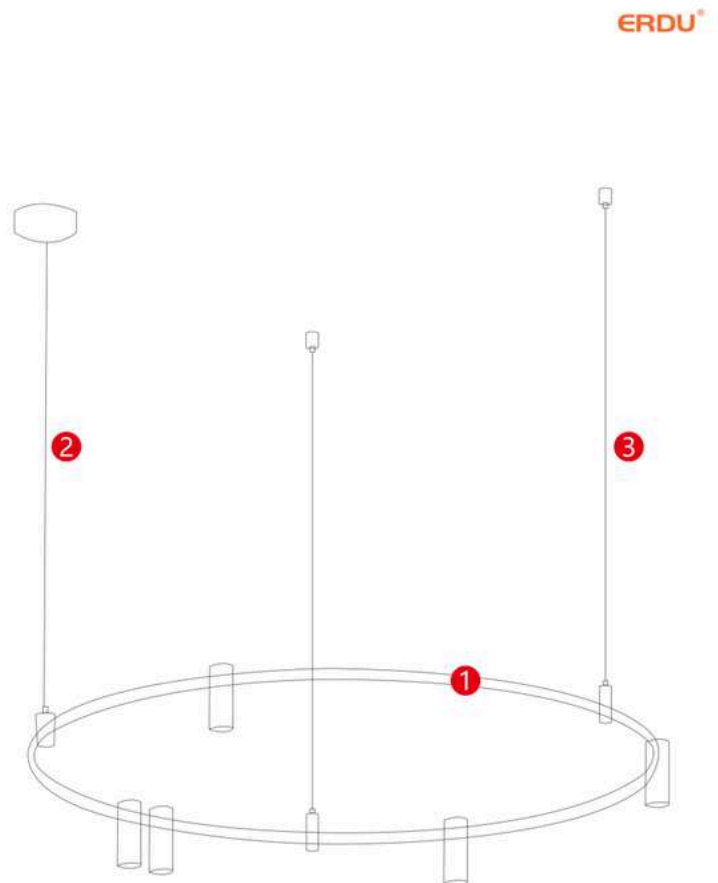



■ 圆圈铝材轨道 Circular aluminum track

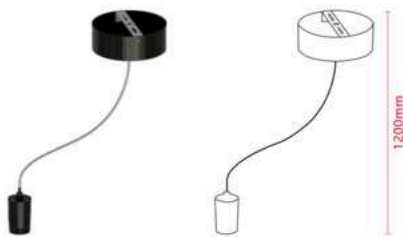

圆形导电吊线配件 型号/Model: YQ1801
Circular conductive hanging wire accessories

产品尺寸: 1200mm吊线

Product Size: 1200mm Hanging line

功能/Function

- | | |
|---------------|--|
| 1. 圆圈导电吊线吸顶盘。 | 1. Circular conductive hanging wire ceiling panel. |
| 2. 轨道供电作用。 | 2. Rail power supply function. |
| 3. 搭配电源器使用。 | 3. Use in conjunction with a power supply. |

安装步骤/Installation steps



■ 圆圈铝材轨道 Circular aluminum track

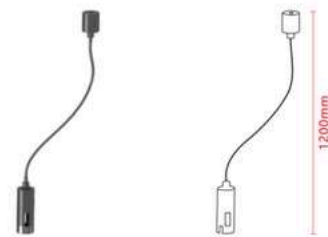

圆形五金吊线配件 型号/Model: YQ1802
Circular hardware hanging wire accessories

产品尺寸: 1200mm吊线

Product Size: 1200mm Hanging line

功能/Function

- | | |
|----------|---------------------------|
| 1. 圆圈吊线。 | 1. Circular hanging line. |
|----------|---------------------------|

安装步骤/Installation steps





■ 电源产品规格书 Power supply product specification sheet

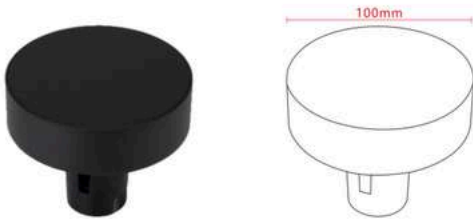

半柔一体电源

Semi-flexible integrated power supply

100/200W

光源型号 Light source model /	功率 Power 100W/200W	尺寸 Size 100mm
扩散罩 Diffuser PC	发光角度 Luminous Angle /	色温 Color temperature /
电压 Diffuser 48V	材质 Luminous Angle 导电头(PC) 铝(Aluminum)	颜色 Colour 黑色/Black
防护等级 Protection grade IP20	使用环境温度 Operating ambient temperature -20°C~40°C	

安装步骤/Installation steps

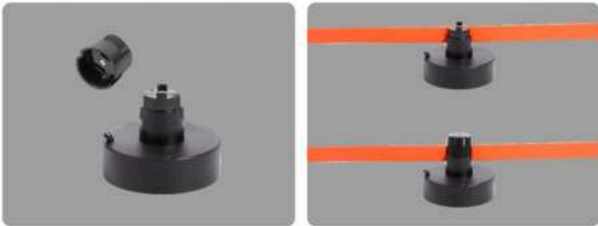

■ 电源产品规格书 Power supply product specification sheet

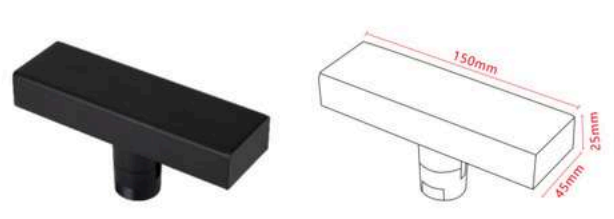

半柔智能一体电源

Semi-flexible intelligent integrated power supply

光源型号 Light source model /	功率 Power 100W/200W	尺寸 Size 45*25*150mm
扩散罩 Diffuser PC	发光角度 Luminous Angle /	色温 Color temperature /
电压 Diffuser 48V	材质 Luminous Angle 导电头(PC) 铝(Aluminum)	颜色 Colour 黑色/Black
防护等级 Protection grade IP20	使用环境温度 Operating ambient temperature -20°C~40°C	

安装步骤/Installation steps





157

158



■ 灯具产品规格书 Specification sheet of Lighting products

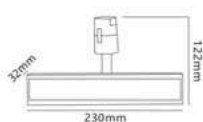

半柔泛光灯 型号/Model: FG1803
Semi-soft floodlight

功率 | Power: 10W 发光角度 | Luminous Angle: 120° 尺寸 | Size: 230*32*122mm

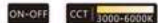

灯体可旋转
The lamp body can rotate



轨道外壳/轨道条颜色可自由更换
The color of the track shell/track strip can be freely changed



电压 | DC48V
Voltage: DC48V
精度: ±90
CR ±90



颜色: 黑/白/金
Color: Black/White/Gold
材质: 铝+PC
Material: Aluminum+PC

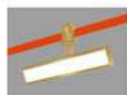

无频闪: <3%
No-Blister: <3%
光学: PC透镜
Optics: PC module

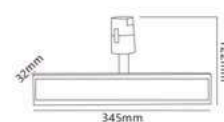

半柔泛光灯 型号/Model: FG1804
Semi-soft floodlight

功率 | Power: 18W 发光角度 | Luminous Angle: 120° 尺寸 | Size: 345*32*122mm



安装方式
Installation method

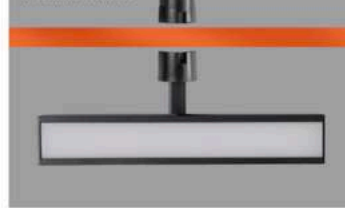



■ 灯具产品规格书 Specification sheet of Lighting products

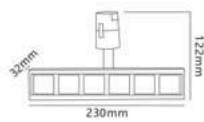

半柔格栅灯 型号/Model: GS1801
Folding grille lamp

功率 | Power: 10W 发光角度 | Luminous Angle: 24° 尺寸 | Size: 230*32*122mm



灯体可旋转
The lamp body can rotate



轨道外壳/轨道条颜色可自由更换
The color of the track shell/track strip can be freely changed



电压 | DC48V
Voltage: 48VDC

误差: ±90
CR ±90



颜色: 黑/白/金
Color: Black/White/Gold
材质: 铝+PC
Material: Aluminum+PC



无频闪: <3%
No Flicker <3%
光学: 透镜
Optics: Lens

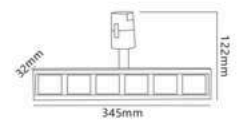

半柔格栅灯 型号/Model: GS1802
Folding grille lamp

功率 | Power: 15W 发光角度 | Luminous Angle: 24° 尺寸 | Size: 345*32*122mm





■ 灯具产品规格书 Specification sheet of Lighting products



半柔射灯 型号/Model: GD1805
Semi-soft spotlights

功率 | Power: 9W 发光角度 | Luminous Angle: 24° 尺寸 | Size: 40*120mm



灯体可旋转
The lamp body can rotate



轨道外壳/轨道条颜色可自由更换
The color of the track shell/track strip can be freely changed



半柔射灯 型号/Model: GD1806
Semi-soft spotlights

功率 | Power: 15W 发光角度 | Luminous Angle: 24° 尺寸 | Size: 60*180mm





灯具产品规格书 Specification sheet of Lighting products

灯体可旋转
The lamp body can rotate

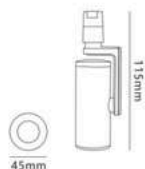

射灯B 型号/Model: GD1807
Spotlight B

功率 | Power: 10W 发光角度 | Luminous Angle: 24° 尺寸 | Size: 45*115mm

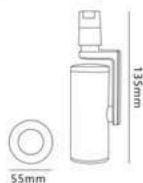

射灯B 型号/Model: GD1808
Spotlight B

功率 | Power: 20W 发光角度 | Luminous Angle: 24° 尺寸 | Size: 55*135mm

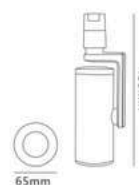

射灯B 型号/Model: GD1809
Spotlight B

功率 | Power: 30W 发光角度 | Luminous Angle: 24° 尺寸 | Size: 65*135mm



轨道外壳/轨道条颜色可自由更换
The color of the track shell/track strip can be freely changed



电压: DC48V
Voltage: DC48V
显指: >90
CRI > 90

颜色: 黑/白/金
Colour: Black/White/Gold
材质: 铝+PC
Material: Aluminium+PC

无频闪 < 3%
No Flicker < 3%
光学: 透镜
Optics: Lens



■ 灯具产品规格书 Specification sheet of Lighting products

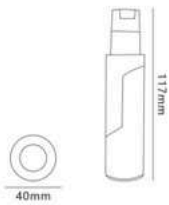

折叠射灯 型号/Model: GD1810
Spotlight B

功率 | Power 7W 发光角度 | Luminous Angle 24° 尺寸 | Size 40*117mm

ON-OFF CCT 3000-6000K

灯体可旋转
The lamp body can rotate



轨道外壳/轨道条颜色可自由更换
The color of the track shell/track strip can be freely changed



电压: DC48V
Voltage: DC48V
显指: ≥90
CRI: ≥90



颜色: 黑/白/金
Colour: Black/White/Gold
材质: 铝+PC
Material: Aluminium+PC



无频闪: <3%
No flicker: <3%
光学: 透镜
Optics: Lens

安装方式
Installation method





■ 灯具产品规格书 Specification sheet of Lighting products



调焦折叠射灯 型号/Model: GD1811
Focus folding spotlights

功率 | Power: 10W 发光角度 | Luminous Angle: 15°-55° 尺寸 | Size: 45*120mm



灯体可旋转
The lamp body can rotate



轨道外壳/轨道条颜色可自由更换
The color of the track shell/track strip can be freely changed



调焦折叠射灯 型号/Model: GD1812
Focus folding spotlights

功率 | Power: 20W 发光角度 | Luminous Angle: 15°-55° 尺寸 | Size: 55*140mm





■ 灯具产品规格书 Specification sheet of Lighting products



半柔D25泛光灯 型号/Model: DG1813
Semi-flexible D25 floodlight

功率 | Power: 10W 发光角度 | Luminous Angle: 280° 尺寸 | Size: 300*108mm



灯体可旋转
The lamp body can rotate



轨道外壳/轨道条颜色可自由更换
The color of the track shell/track strip can be freely changed



半柔D25泛光灯 型号/Model: DG1814
Semi-flexible D25 floodlight

功率 | Power: 20W 发光角度 | Luminous Angle: 280° 尺寸 | Size: 600*108mm





■ 灯具产品规格书 Specification sheet of Lighting products



半柔硅胶灯带 型号/Model: DG1824
Semi-flexible silicone light strips

功率 | Power: 10W 发光角度 | Luminous Angle: 360° 尺寸 | Size: 1000*21mm

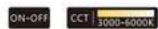

灯体可旋转
The lamp body can rotate



轨道外壳/轨道条颜色可自由更换
The color of the track shell/track strip can be freely changed



半柔硅胶灯带 型号/Model: DG1825
Semi-flexible silicone light strips

功率 | Power: 20W 发光角度 | Luminous Angle: 360° 尺寸 | Size: 2000*21mm

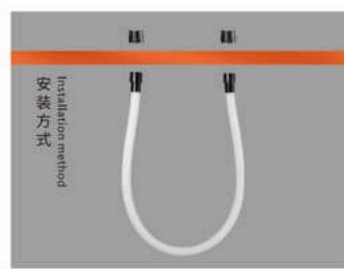



■ 灯具产品规格书 Specification sheet of Lighting products

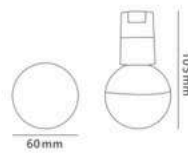

半柔小圆球 型号/Model: YQ1815
Semi-soft small ball

功率 | Power 7W 发光角度 | Luminous Angle 180° 尺寸 | Size 105*60mm



轨道外壳/轨道条颜色可自由更换
The color of the track shell/track strip can be freely changed



- 电压 | DC48V
Voltage | DC48V
- 颜色: 黑/白/金
Colour: Black/White/Gold
- 无频闪: <3%
No Flicker: <3%
- 材质: 铝+PC
Material: Aluminum+PC
- 光束: ±90
Beam: ±90
- 光学: PC透镜
Optics: PC Module





■ 灯具产品规格书 Specification sheet of Lighting products

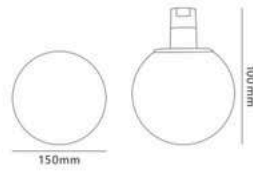

半柔球泡灯 型号/Model: YQ1816
Semi-flexible bulb lamp

功率 | Power 7W 发光角度 | Luminous Angle 180° 尺寸 | Size 150*100 mm



轨道外壳/轨道条颜色可自由更换
The color of the track shell/track strip can be freely changed



- 电压: DC48V
Voltage: DC48V

频闪: ≤90
Ch: ≤90
- 颜色: 黑/白/金
Colour: Black/White/Gold

材质: 铝+PC
Material: Aluminium+PC
- 无频闪: <3%
No-Flicker: <3%

光学: PC透镜
Optics: PC Module



安装方式
Installation method



■ 灯具产品规格书 Specification sheet of Lighting products

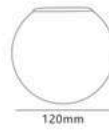

圆球吊线灯 型号/Model: DX1832
Spherical hanging line lamp

功率 | Power 7W 发光角度 | Luminous Angle 105° 尺寸 | Size 120mm



轨道外壳/轨道条颜色可自由更换
The color of the track shell/track strip can be freely changed





■ 灯具产品规格书 Specification sheet of Lighting products

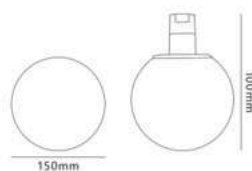

球中球 型号/Model: YQ1820
A ball within a ball

功率 | Power 5W 发光角度 | Luminous Angle 180° 尺寸 | Size 150*100mm



轨道外壳/轨道条颜色可自由更换
The color of the track shell/track strip can be freely changed.



- 电压: DC48V
Voltage: DC48V
- 颜色: 黑/白/金
Color: Black/White/Gold
- 无频闪: <3%
No Flicker: <3%
- 显指: ≥90
CRI: ≥90
- 材质: 铝+PC
Material: Aluminum+PC
- 光学: PC透镜
Optics: PC Module





■ 灯具产品规格书 Specification sheet of Lighting products

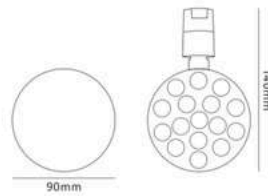

半柔圆盘格栅灯 型号/Model: YS1818
Semi-flexible disc grille lamp

功率 | Power 10W 发光角度 | Luminous Angle 24° 尺寸 | Size 140*90mm

ON-OFF CCT 3000-6000K

灯体可旋转
The lamp body can rotate



轨道外壳/轨道条颜色可自由更换
The color of the track shell/track strip can be freely changed.





■ 灯具产品规格书 Specification sheet of Lighting products



半柔筒射灯 型号/Model: MZ1817
Semi-flexible tube spotlights

功率 | Power 7W 发光角度 | Luminous Angle 24° 尺寸 | Size 38*100mm



轨道外壳/轨道条颜色可自由更换
The color of the track shell/track strip can be freely changed.

 电压: DC48V Voltage: DC48V	 颜色: 黑/白/金 Color: Black/White/Gold	 无频闪: <3% No Flicker: <3%
 梁角: ≥90° Beam: ≥90°	 材质: 铝+PC Material: Aluminum+PC	 光学: 透镜 Optics Lens





■ 灯具产品规格书 Specification sheet of Lighting products

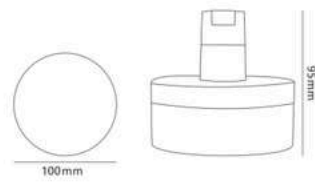

半柔亚克力泛光灯 型号/Model: YQ1821
Semi-flexible acrylic floodlight

功率 | Power 6W 发光角度 | Luminous Angle 120° 尺寸 | Size 100*95mm



轨道外壳/轨道条颜色可自由更换
The color of the track shell/track strip can be freely changed



- 电压: DC48V
Voltage: DC48V
- 颜色: 黑/白/金
Colour: Black/White/Gold
- 光斑角: $\le 30^\circ$
- 材质: 铝+PC
Material: Aluminium+PC
- 无频闪: <math>< 3\%</math>
No flicker: <math>< 3\%</math>
- 光学: PC模块
Optics: PC module





■ 灯具产品规格书 Specification sheet of Lighting products

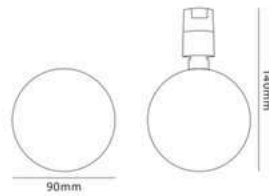

半柔圆形盘泛光灯 型号/Model: YF1819
Semi-flexible circular disc floodlight

功率 | Power 10W 发光角度 | Luminous Angle 105° 尺寸 | Size 140*90mm

ON-OFF CCT 3000-6000K

灯体可旋转
 The lamp body can rotate



轨道外壳/轨道条颜色可自由更换
 The color of the track shell/track strip can be freely changed

 电压: DC48V Voltage: DC48V	 颜色: 黑/白/金 Color: Black/White/Gold	 无频闪: <3% No Flicker: <3%
 梁角: ≥90° Or: ≥90°	 材质: 铝+PC Material: Aluminum+PC	 光学: PC透镜 Optics: PC lens





■ 灯具产品规格书 Specification sheet of Lighting products

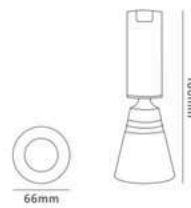

半柔圆锥款射灯 型号/Model: YJ1828
Semi-flexible conical spotlights

功率 | Power 7W 发光角度 | Luminous Angle 24° 尺寸 | Size 160*66mm

ON-OFF CCT 3000-6000K

灯体可旋转
The lamp body can rotate



轨道外壳/轨道条颜色可自由更换
The color of the track shell/track strip can be freely changed.

<p>电压: DC48V Voltage: DC48V</p> <p>功率: ≥90 Oh ≥90</p>	<p>颜色: 黑/白/金 Colour: Black/White/Gold</p> <p>材质: 铝+PC Material: Aluminum+PC</p>	<p>无频闪: <3% No flicker: <3%</p> <p>光学: 透镜 Optics Lens</p>





■ 灯具产品规格书 Specification sheet of Lighting products

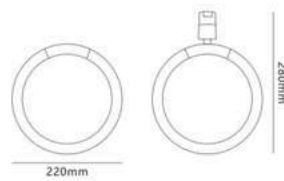

圆环灯 型号/Model: YH1823
Circular lamp

功率 | Power 8W 发光角度 | Luminous Angle 360° 尺寸 | Size 220*280mm

ON-OFF CCT 3000-6000K

灯体可旋转
The lamp body can rotate



轨道外壳/轨道条颜色可自由更换
The color of the track shell/track strip can be freely changed.





■ 灯具产品规格书 Specification sheet of Lighting products

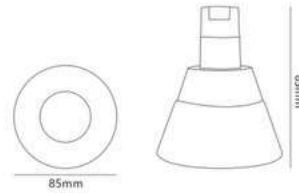

亚克力吊线灯 型号/Model: DX1830
Acrylic hanging line lamp

功率 | Power 7W 发光角度 | Luminous Angle 105° 尺寸 | Size 85*85mm



轨道外壳/轨道条颜色可自由更换
The color of the track shell/track strip can be freely changed





■ 灯具产品规格书 Specification sheet of Lighting products

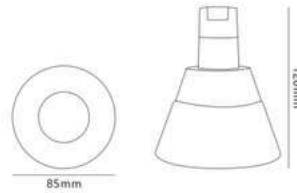

半柔圆锥款亚克力射灯 型号/Model: BL1829
Semi-flexible conical acrylic spotlights

功率 | Power 6W 发光角度 | Luminous Angle 105° 尺寸 | Size 85*120mm



轨道外壳/轨道条颜色可自由更换
The color of the track shell/track strip can be freely changed.





■ 灯具产品规格书 Specification sheet of Lighting products



半柔D12长管灯 型号/Model: XS1822
Semi-flexible D12 long tube lamp

功率 | Power 2W 发光角度 | Luminous Angle 18° 尺寸 | Size 10*600mm

ON-OFF CCT 3000-6000K

灯体可旋转
 The lamp body can rotate



轨道外壳/轨道条颜色可自由更换
 The color of the track shell/track strip can be freely changed

<p>电压: DC48V Voltage: DC48V</p> <p>显指: ≥90 CRI ≥90</p>	<p>颜色: 黑/白/金 Color: Black/White/Gold</p> <p>材质: 铝+PC Material: Aluminum+PC</p>	<p>无频闪: <3% No Flicker <3%</p> <p>光学: 透镜 Optics Lens</p>





■ 灯具产品规格书 Specification sheet of Lighting products

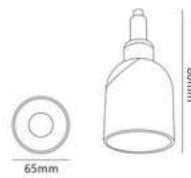

万向吊线灯 型号/Model: DX1833
Universal hanging wire lamp

功率 | Power 10W 发光角度 | Luminous Angle 24° 尺寸 | Size 65*80mm

ON-OFF CCT | 3000-6000K

轨道外壳/轨道条颜色可自由更换
 The color of the track shell/track strip can be freely changed.





■ 灯具产品规格书 Specification sheet of Lighting products

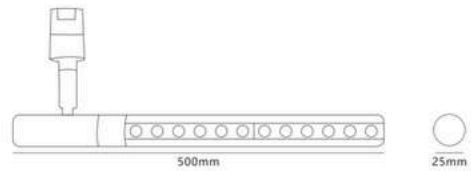

拼接旋转射灯 型号/Model: PJ1827
Spliced rotating spotlights

功率 | Power 15W 发光角度 | Luminous Angle 24° 尺寸 | Size 25*500mm

ON-OFF CCT 3000-6000K

灯体可旋转
 The lamp body can rotate



轨道外壳/轨道条颜色可自由更换
 The color of the track shell/track strip can be freely changed.

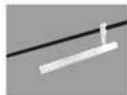

电压: DC48V
 Voltage: DC48V



梁角: ≥90°
 OA: ≥90°



颜色: 黑/白/金
 Color: Black/White/Gold



材质: 铝+PC
 Material: Aluminum+PC



无频闪: <3%
 No Flicker: <3%



光学: PC透镜
 Optics: PC Module





■ 灯具产品规格书 Specification sheet of Lighting products

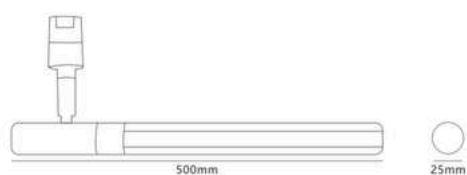

拼接旋转泛光灯 型号/Model: PJ1826
Spliced rotating floodlights

功率 | Power 15W 发光角度 | Luminous Angle 105° 尺寸 | Size 25*500mm

ON-OFF CCT 3000-6000K

灯体可旋转
 The lamp body can rotate



轨道外壳/轨道条颜色可自由更换
 The color of the track shell/track strip can be freely changed.



电压: DC48V
 Voltage: DC48V



颜色: 黑/白/金
 Color: Black/White/Gold



无频闪: < 3%
 No Flicker: < 3%

显指: ≥90
 CRI ≥90

材质: 铝+PC
 Material: Aluminum+PC

光学: PC透镜
 Optics: PC module





207

208

ERDU®

ERDU®

光与空间关系

以光之力,与艺相辅,以光的融合度为空间带来丰富的生命活力,在日与夜的变化之中,通过微妙的色调改变着整个空间的氛围。

The relationship between light and space

With the power of light, complementing art, the fusion of light brings rich vitality to the parachute. In the changes of day and night, it alters the atmosphere of the entire space through subtle tones.



209

210